





Access Control Terminal

User Manual

Symbol Conventions

The symbols that may be found in this document are defined as follows.

Symbol	Description
 Danger	Indicates a hazardous situation which, if not avoided, will or could result in death or serious injury.
 Caution	Indicates a potentially hazardous situation which, if not avoided, could result in equipment damage, data loss, performance degradation, or unexpected results.
 Note	Provides additional information to emphasize or supplement important points of the main text.

Regulatory Information

FCC Information

Please take attention that changes or modification not expressly approved by the party responsible for compliance could void the user's authority to operate the equipment.

FCC compliance: This equipment has been tested and found to comply with the limits for a Class B digital device, pursuant to part 15 of the FCC Rules. These limits are designed to provide reasonable protection against harmful interference in a residential installation. This equipment generates, uses and can radiate radio frequency energy and, if not installed and used in accordance with the instructions, may cause harmful interference to radio communications. However, there is no guarantee that interference will not occur in a particular installation. If this equipment does cause harmful interference to radio or television reception, which can be determined by turning the equipment off and on, the user is encouraged to try to correct the interference by one or more of the following measures:

- Reorient or relocate the receiving antenna.
- Increase the separation between the equipment and receiver.
- Connect the equipment into an outlet on a circuit different from that to which the receiver is connected.
- Consult the dealer or an experienced radio/TV technician for help

This equipment should be installed and operated with a minimum distance 20cm between the radiator and your body.

FCC Conditions

This device complies with part 15 of the FCC Rules. Operation is subject to the following two conditions:

1. This device may not cause harmful interference.
2. This device must accept any interference received, including interference that may cause undesired operation.

EU Conformity Statement



This product and - if applicable - the supplied accessories too are marked with "CE" and comply therefore with the applicable harmonized European standards listed under the EMC Directive 2014/30/EU, the RoHS Directive 2011/65/EU



2012/19/EU (WEEE directive): Products marked with this symbol cannot be disposed of as unsorted municipal waste in the European Union. For proper recycling, return this product to your local supplier upon the purchase of equivalent new equipment, or dispose of it at designated collection points. For more information see: www.recyclethis.info



2006/66/EC (battery directive): This product contains a battery that cannot be disposed of as unsorted municipal waste in the European Union. See the product documentation for specific battery information. The battery is marked with this symbol, which may include lettering to indicate cadmium (Cd), lead (Pb), or mercury (Hg). For proper recycling, return the battery to your supplier or to a designated collection point. For more information see: www.recyclethis.info

Industry Canada ICES-003 Compliance

This device meets the CAN ICES-3 (B)/NMB-3(B) standards requirements.

This device complies with Industry Canada licence-exempt RSS standard(s). Operation is subject to the following two conditions:

1. this device may not cause interference, and
2. this device must accept any interference, including interference that may cause undesired operation of the device.

Le présent appareil est conforme aux CNR d'Industrie Canada applicables aux appareils radioexempts de licence. L'exploitation est autorisée aux deux conditions suivantes :

1. l'appareil ne doit pas produire de brouillage, et
2. l'utilisateur de l'appareil doit accepter tout brouillage radioélectrique subi, même si le brouillage est susceptible d'en compromettre le fonctionnement.

Under Industry Canada regulations, this radio transmitter may only operate using an antenna of a type and maximum (or lesser) gain approved for the transmitter by Industry Canada. To reduce potential radio interference to other users, the antenna type and its gain should be so chosen that the equivalent isotropically radiated power (e.i.r.p.) is not more than that necessary for successful communication.

Conformément à la réglementation d'Industrie Canada, le présent émetteur radio peut fonctionner avec une antenne d'un type et d'un gain maximal (ou inférieur) approuvé pour l'émetteur par Industrie Canada. Dans le but de réduire les risques de brouillage radioélectrique à l'intention des autres utilisateurs, il faut choisir le type d'antenne et son gain de sorte que la puissance isotrope

rayonnée équivalente (p.i.r.e.) ne dépasse pas l'intensité nécessaire à l'établissement d'une communication satisfaisante.

This equipment should be installed and operated with a minimum distance 20cm between the radiator and your body.

Cet équipement doit être installé et utilisé à une distance minimale de 20 cm entre le radiateur et votre corps.



Safety Instruction

These instructions are intended to ensure that user can use the product correctly to avoid danger or property loss.

The precaution measure is divided into Dangers and Cautions:

Dangers: Neglecting any of the warnings may cause serious injury or death.

Cautions: Neglecting any of the cautions may cause injury or equipment damage.

	
Dangers: Follow these safeguards to prevent serious injury or death.	Cautions: Follow these precautions to prevent potential injury or material damage.

Dangers

- All the electronic operation should be strictly compliance with the electrical safety regulations, fire prevention regulations and other related regulations in your local region.
- Please use the power adapter, which is provided by normal company. The power consumption cannot be less than the required value.
- Do not connect several devices to one power adapter as adapter overload may cause over-heat or fire hazard.
- Please make sure that the power has been disconnected before you wire, install or dismantle the device.
- When the product is installed on wall or ceiling, the device shall be firmly fixed.
- If smoke, odors or noise rise from the device, turn off the power at once and unplug the power cable, and then please contact the service center.
- Do not ingest battery, Chemical Burn Hazard.
This product contains a coin/button cell battery. If the coin/button cell battery is swallowed, it can cause severe internal burns in just 2 hours and can lead to death.
Keep new and used batteries away from children. If the battery compartment does not close securely, stop using the product and keep it away from children. If you think batteries might have been swallowed or placed inside any part of the body, seek immediate medical attention.
- If the product does not work properly, please contact your dealer or the nearest service center. Never attempt to disassemble the device yourself. (We shall not assume any responsibility for problems caused by unauthorized repair or maintenance.)

Cautions

- This equipment is not suitable for use in locations where children are likely to be present.
- Do not drop the device or subject it to physical shock, and do not expose it to high electromagnetism radiation. Avoid the equipment installation on vibrations surface or places subject to shock (ignorance can cause equipment damage).

- Do not place the device in extremely hot (refer to the specification of the device for the detailed operating temperature), cold, dusty or damp locations, and do not expose it to high electromagnetic radiation.
- The device cover for indoor use shall be kept from rain and moisture.
- Exposing the equipment to direct sun light, low ventilation or heat source such as heater or radiator is forbidden (ignorance can cause fire danger).
- Do not aim the device at the sun or extra bright places. A blooming or smear may occur otherwise (which is not a malfunction however), and affecting the endurance of sensor at the same time.
- Please use the provided glove when open up the device cover, avoid direct contact with the device cover, because the acidic sweat of the fingers may erode the surface coating of the device cover.
- Please use a soft and dry cloth when clean inside and outside surfaces of the device cover, do not use alkaline detergents.
- Please keep all wrappers after unpack them for future use. In case of any failure occurred, you need to return the device to the factory with the original wrapper. Transportation without the original wrapper may result in damage on the device and lead to additional costs.
- Improper use or replacement of the battery may result in hazard of explosion. Replace with the same or equivalent type only. Dispose of used batteries according to the instructions provided by the battery manufacturer.

Available Models

The access control terminal contains the following models:

Product Name	Product	Wireless
Access Control Terminal	With Fingerprint Function	13.56 MHz Card Presenting Frequency, Wi-Fi, 2.4G,Bluetooth
	Without Fingerprint Function	13.56 MHz Card Presenting Frequency, Wi-Fi, 2.4G,Bluetooth

Table 1-1 Available Mobile Web Browsers

Operation System	Browser	Version	Available
Android	Xiaomi 12, default browser	16.6.6	Yes
	Huawei P30, default browser	12.1.1.321	Yes
	Xiaomi 5s plus, default browser	14.2.22	Yes
	Huawei P30 Pro, default browser	12.1.2.301	Yes
	Redmi k40, default browser	16.5.12	Yes
IOS	Safari	15.4	Yes

Contents

Chapter 1 Overview	1
Chapter 2 Features	2
Chapter 3 Appearance Description	3
Chapter 4 Installation	5
4.1 Installation Environment	5
4.2 Install without Gang Box	5
Chapter 5 Device Wiring	9
5.1 Terminal Description	9
5.2 External Device Wiring	11
5.3 Wire Secure Door Control Unit	11
Chapter 6 Activation	13
6.1 Activate via Web Browser	13
6.2 Activate Device via iVMS-4200 Client Software	13
Chapter 7 Operation via Web Browser	15
7.1 Login	15
7.2 Forget Password	15
7.3 Live View	15
7.4 Person Management	17
7.5 Search Event	18
7.6 Device Management	20
7.7 Configuration	21
7.7.1 Set Local Parameters	21
7.7.2 View Device Information	21
7.7.3 Set Time	21
7.7.4 Set DST	22
7.7.5 View Open Source Software License	23

7.7.6 Upgrade and Maintenance	23
7.7.7 Log Query	24
7.7.8 Security Mode Settings	24
7.7.9 Certificate Management	25
7.7.10 Change Administrator's Password	26
7.7.11 View Device Arming/Disarming Information	27
7.7.12 Online Users	27
7.7.13 Network Settings	27
7.7.14 Set Video and Audio Parameters	32
7.7.15 Set Image Parameters	33
7.7.16 Event Linkage	34
7.7.17 General Settings	35
7.7.18 Access Control Settings	39
7.7.19 Video Intercom Settings	43
7.7.20 Set Basic Parameters	45
Chapter 8 Configure the Device via the Mobile Browser	46
8.1 Login	46
8.2 Search Event	46
8.3 User Management	46
8.4 Configuration	48
8.4.1 View Device Information	48
8.4.2 Time Settings	48
8.4.3 Set DST	49
8.4.4 View Open Source Software License	51
8.4.5 User Management	51
8.4.6 Upgrade and Maintenance	51
8.4.7 Security Settings	52
8.4.8 Network Settings	52

8.4.9 General Settings	56
8.4.10 Face Parameters Settings	61
8.4.11 Video Intercom Settings	62
8.4.12 Access Control Settings	64
8.5 Door Operation	69
Chapter 9 Client Software Configuration	71
9.1 Configuration Flow of Client Software	71
9.2 Device Management	72
9.2.1 Add Device	72
9.2.2 Reset Device Password	76
9.2.3 Manage Added Devices	77
9.3 Group Management	77
9.3.1 Add Group	77
9.3.2 Import Resources to Group	78
9.4 Person Management	78
9.4.1 Add Organization	78
9.4.2 Configure Basic Information	79
9.4.3 Issue a Card by Local Mode	81
9.4.4 Collect Fingerprint via Client	82
9.4.5 Collect Fingerprint via Access Control Device	83
9.4.6 Configure Access Control Information	84
9.4.7 Customize Person Information	86
9.4.8 Configure Additional Information	86
9.4.9 Import and Export Person Identify Information	87
9.4.10 Import Person Information	87
9.4.11 Export Person Information	87
9.4.12 Get Person Information from Access Control Device	88
9.4.13 Move Persons to Another Organization	89

- 9.4.14 Issue Cards to Persons in Batch 89
- 9.4.15 Report Card Loss 89
- 9.4.16 Set Card Issuing Parameters 90
- 9.5 Configure Schedule and Template 91
 - 9.5.1 Add Holiday 91
 - 9.5.2 Add Template 92
- 9.6 Set Access Group to Assign Access Authorization to Persons 93
- 9.7 Configure Advanced Functions 95
 - 9.7.1 Configure Device Parameters 95
 - 9.7.2 Configure Remaining Unlocked/Locked 100
 - 9.7.3 Configure Custom Wiegand Rule 101
 - 9.7.4 Configure Card Reader Authentication Mode and Schedule 102
 - 9.7.5 Configure Device Parameters 104
- 9.8 Configure Linkage Actions for Access Control 108
 - 9.8.1 Configure Client Actions for Access Event 108
 - 9.8.2 Configure Device Actions for Access Event 109
 - 9.8.3 Configure Device Actions for Card Swiping 109
 - 9.8.4 Configure Device Actions for Person ID 110
- 9.9 Door Control 111
 - 9.9.1 Control Door Status 111
 - 9.9.2 Check Real-Time Access Records 112
- Appendix A. Tips for Scanning Fingerprint 114**
- Appendix B. Dimension 116**

Chapter 1 Overview

Access control terminal is a kind of access control terminal for authentication. It supports two-way audio, remote live view, picture capture, video recording through NVR, and so on.

Chapter 2 Features

- Manage access control, video intercoms, and video security with one device
- IP65 & IK09 protections, as well as increased stability with zinc alloy materials
- Multiple authentication methods, including fingerprint, card, etc.



Note

Fingerprint function is supported by parts of the device modules.

- Remote control via the Guarding Vision mobile app
- Connects to external access controller via Wiegand protocol
- Two-way audio via SIP 2.0 protocol
- RS-485 communication for connecting external card reader

Chapter 3 Appearance Description

View the device appearance description.

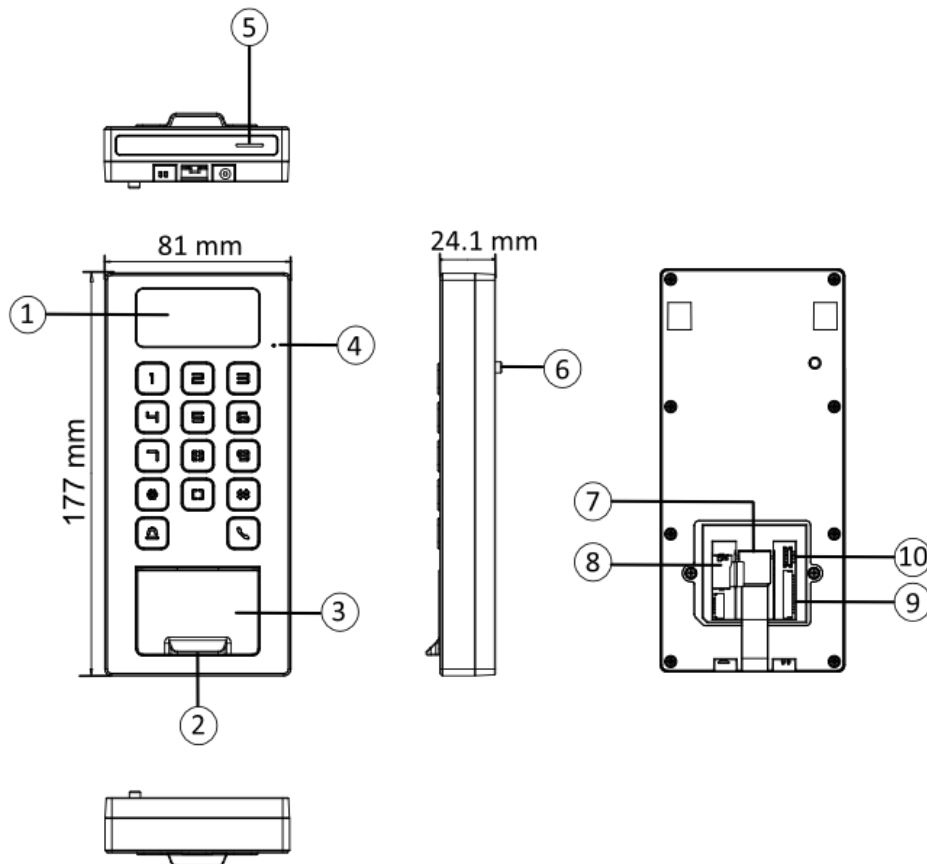

Note

The pictures here are for reference only.

Table 3-1 Appearance Description

No.	Description
1	Camera (Supported by parts of Device Models)
2	Fingerprint Module (Supported by parts of Device Models)
3	Card Presenting Area

Access Control Terminal User Manual

No.	Description
4	MIC
5	Loudspeaker
6	Tamper
7	Network Interface
8	SD Card Slot
9	Wiring Terminal
10	Debugging Port (For debugging only)

Chapter 4 Installation

4.1 Installation Environment

- Install the device at least 2 meters away from the light, and at least 3 meters away from the window or the door.
- Make sure the environment illumination is more than 100 Lux.



For details about installation environment, see *Tips for Installation Environment*.

4.2 Install without Gang Box

Steps



The additional force shall be equal to three times the weight of the equipment. The equipment and its associated mounting means shall remain secure during the installation. After the installation, the equipment, including any associated mounting plate, shall not be damaged.

1. Secure the mounting plate on the wall with 4 supplied screws (SC-KA4X25-SUS).

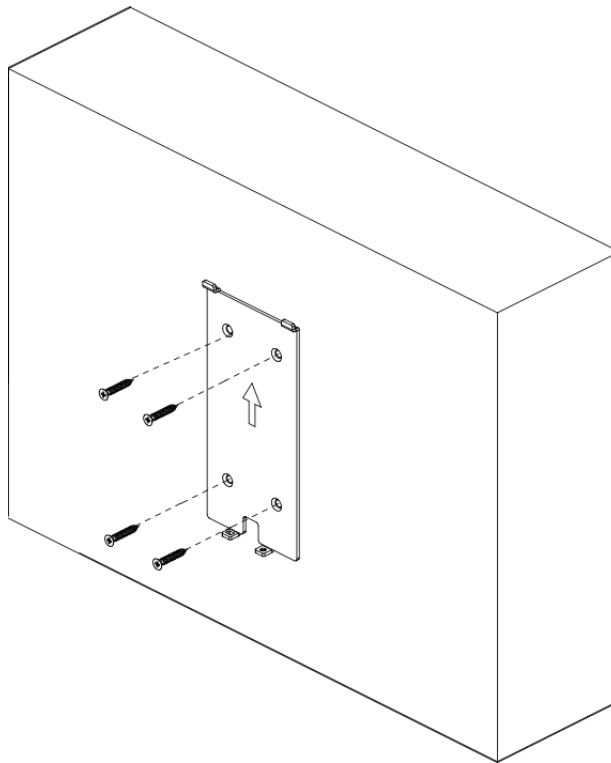
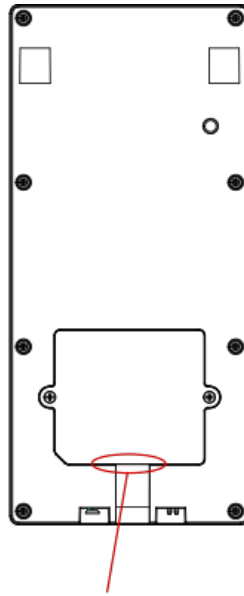

Figure 4-1 Secure Mounting Plate

2. Route the cable through the cable hole of the mounting plate, and connect to corresponding external devices' cables.
3. Apply Silicone sealant among the joints between the device rear panel and the wall (except the lower side) to keep the raindrop from entering.



Apply
Silicone
Sealant

Figure 4-2 Apply Silicone Sealant on the Side

4. Align the device with the mounting plate, and secure the device on the mounting plate with 1 supplied screw (SC-KM3X6-T10-SUS).

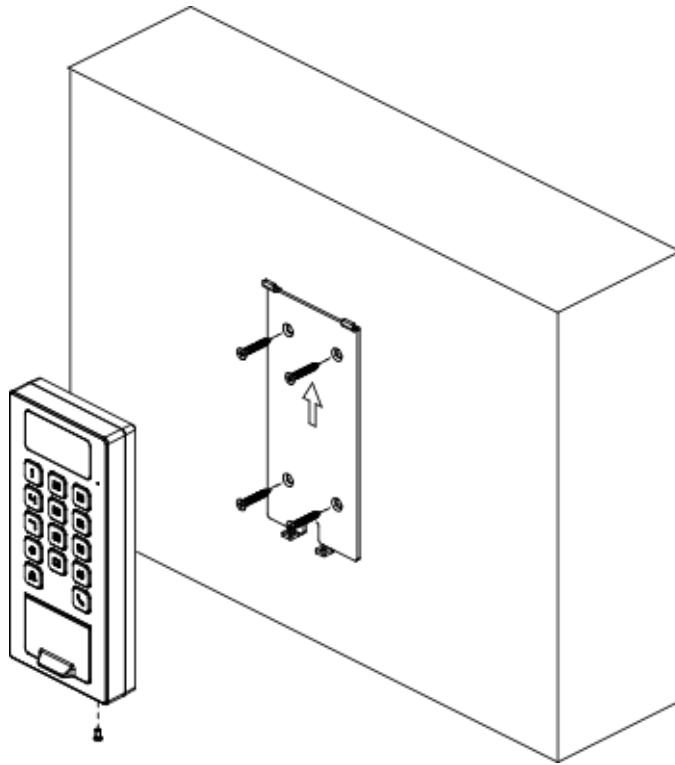

Figure 4-3 Secure Device

Chapter 5 Device Wiring

5.1 Terminal Description

The terminals contains power input, alarm input, alarm output, RS-485, Wiegand output, and door lock.

The terminal's diagram is as follows:

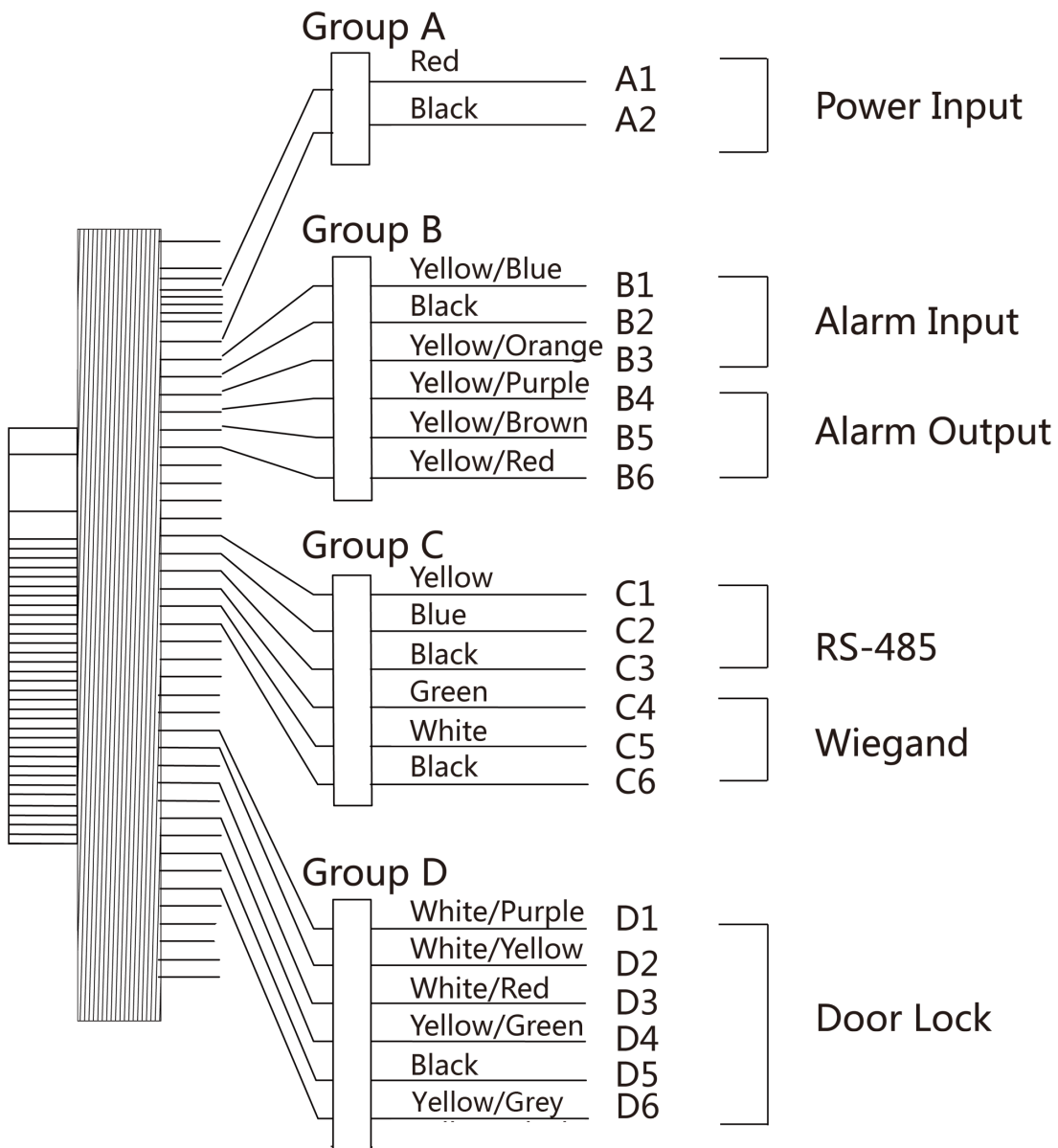

Figure 5-1 Terminal Diagram

The descriptions of the terminals are as follows:

Table 5-1 Terminal Descriptions

Group	No.	Function	Color	Name	Description
Group A	A1	Power Input	Red	+12 V	12 VDC Power Supply
	A2		Black	GND	Ground
Group B	B1	Alarm Input	Yellow/Blue	IN1	Alarm Input 1
	B2		Black	GND	Ground
	B3		Yellow/Orange	IN2	Alarm Input 2
	B4	Alarm Output	Yellow/Purple	NC	Alarm Output Wiring
	B5		Yellow/Brown	COM	
	B6		Yellow/Red	NO	
Group C	C1	RS-485	Yellow	485+	RS-485 Wiring
	C2		Blue	485-	
	C3		Black	GND	
	C4	Wiegand	Green	W0	Wiegand Wiring 0
	C5		White	W1	Wiegand Wiring 1
	C6		Black	GND	Ground
Group D	D1	Door Lock	White/Purple	NC	Lock Wiring (NC)
	D2		White/Yellow	COM	Common
	D3		White/Red	NO	Lock Wiring (NO)
	D4		Yellow/Green	SENSOR	Door Contact
	D5		Black	GND	Ground
	D6		Yellow/Gray	BTN	Exit Door Wiring

5.2 External Device Wiring

Wire the external device.

The wiring diagram is as follows.

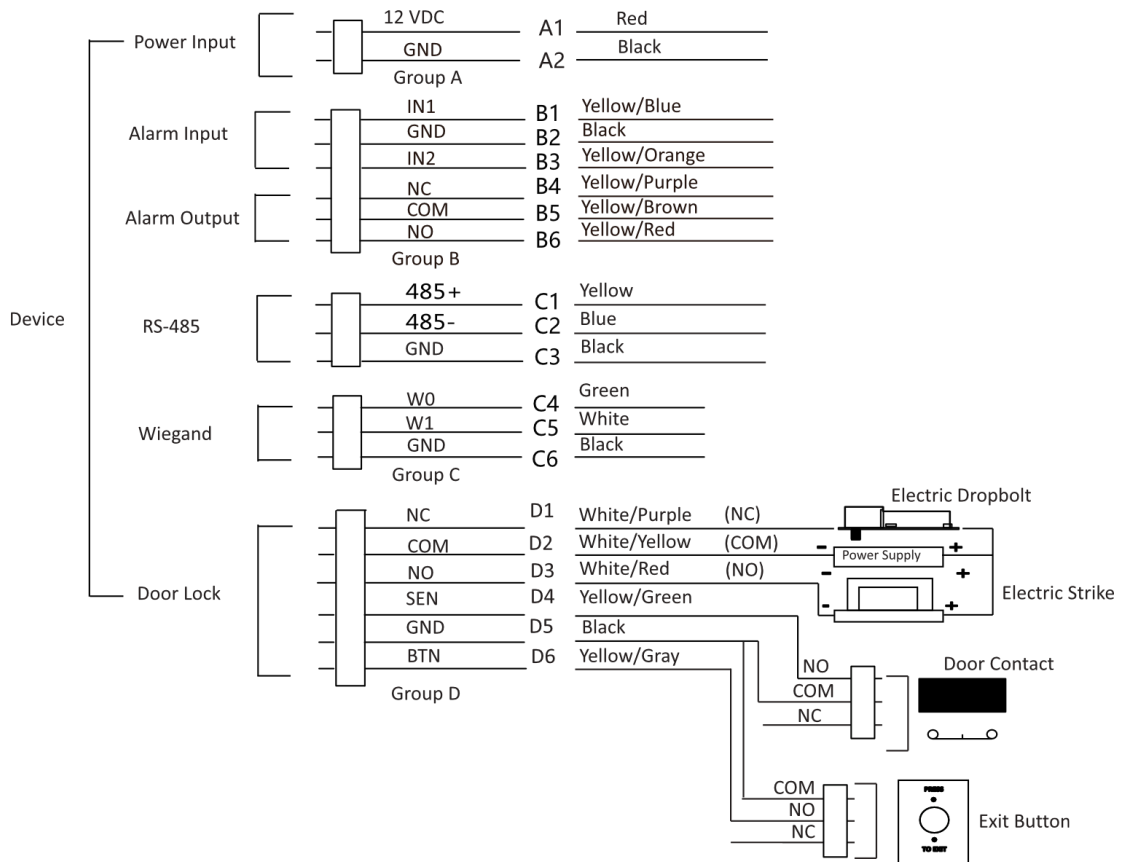

Figure 5-2 External Device Wiring

5.3 Wire Secure Door Control Unit

You can connect the terminal with the secure door control unit.

The wiring diagram is as follows.

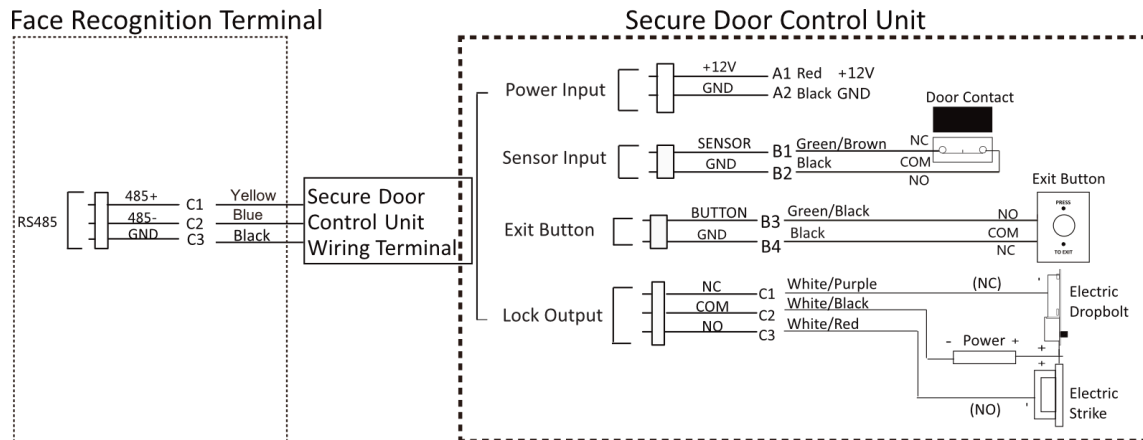

Figure 5-3 Secure Door Control Unit Wiring

Note

- The secure door control unit should connect to an external power supply separately. The suggested external power supply is 12V, 0.5A.
- For scenarios with high safety requirement, use the secure door control unit wiring first.
- You can ask the technical support to purchase for the secure door control unit separately.
- The picture here are parts of the wiring. For details, see the secure door control unit's user manual.

Chapter 6 Activation

You should activate the device before the first login. After powering on the device, the system will switch to Device Activation page.

Activation via the device, SADP tool and the client software are supported.

The default values of the device are as follows:

- The default IP address: 192.0.0.64
- The default port No.: 8000
- The default user name: admin

6.1 Activate via Web Browser

You can activate the device via the web browser.

Steps

1. Enter the device default IP address (192.0.0.64) in the address bar of the web browser, and press **Enter**.



Make sure the device IP address and the computer's should be in the same IP segment.

2. Create a new password (admin password) and confirm the password.



STRONG PASSWORD RECOMMENDED-We highly recommend you create a strong password of your own choosing (using a minimum of 8 characters, including upper case letters, lower case letters, numbers, and special characters) in order to increase the security of your product. And we recommend you reset your password regularly, especially in the high security system, resetting the password monthly or weekly can better protect your product.



Characters containing admin and nimda are not supported to be set as activation password.

3. Click **Activate**.
4. Edit the device IP address. You can edit the IP address via the SADP tool, the device, and the client software.

6.2 Activate Device via iVMS-4200 Client Software

For some devices, you are required to create the password to activate them before they can be added to the iVMS-4200 software and work properly.

Steps

Note

This function should be supported by the device.

1. Enter the Device Management page.
 2. Click  on the right of **Device Management** and select **Device**.
 3. Click **Online Device** to show the online device area.
The searched online devices are displayed in the list.
 4. Check the device status (shown on **Security Level** column) and select an inactive device.
 5. Click **Activate** to open the Activation dialog.
 6. Create a password in the password field, and confirm the password.
-

Caution

The password strength of the device can be automatically checked. We highly recommend you change the password of your own choosing (using a minimum of 8 characters, including at least three kinds of following categories: upper case letters, lower case letters, numbers, and special characters) in order to increase the security of your product. And we recommend you change your password regularly, especially in the high security system, changing the password monthly or weekly can better protect your product.

Proper configuration of all passwords and other security settings is the responsibility of the installer and/or end-user.

Note

Characters containing admin and nimda are not supported to be set as activation password.

7. Click **OK** to activate the device.

Chapter 7 Operation via Web Browser

7.1 Login

You can login via the web browser or the remote configuration of the client software.



Make sure the device is activated. For detailed information about activation, see [Activation](#) .

Login via Web Browser

Enter the device IP address in the address bar of the web browser and press **Enter** to enter the login page.

Enter the device user name and the password. Click **Login**.

Login via Remote Configuration of Client Software

Download and open the client software. After adding the device, click  to enter the Configuration page.

7.2 Forget Password

If you forget the password when logging in, you can change the password by email address or security questions.

On the login page, click **Forget Password**.

Select **Verification Mode**.

Security Question Verification

Answer the security questions.

E-mail Verification

1. Export the QR code and send it to the server email address as attachment.
2. You will receive a verification code within 5 minutes in your reserved email.
3. Enter the verification code into the verification code field to verify your identification.

Click **Next**, create a new password and confirm it.

7.3 Live View

You can view the live video of the device.

After logging in, you will enter the live view page. You can perform the live view, capture, video recording, and other operations.

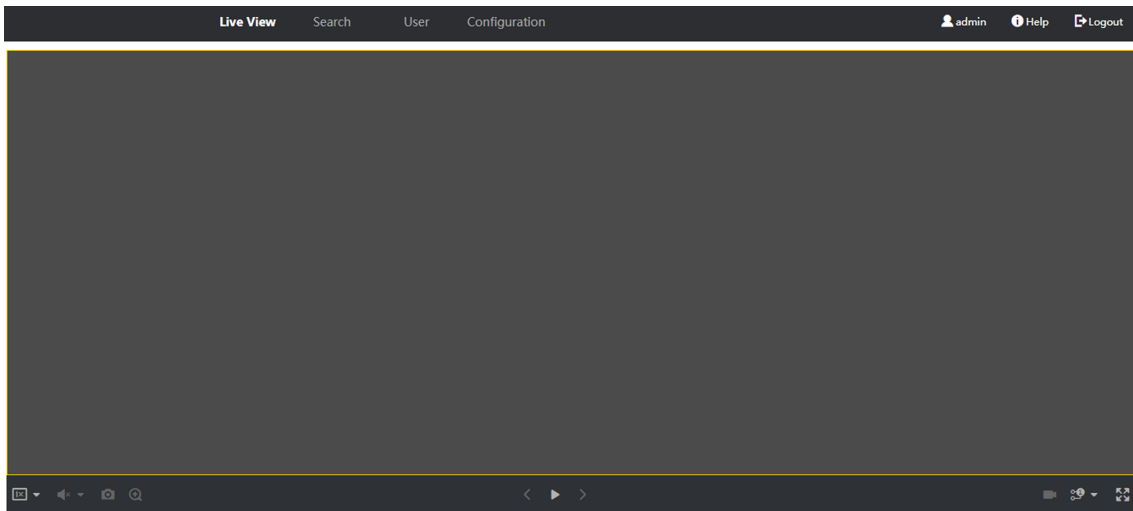

Figure 7-1 Live View Page

Function Descriptions:



Select the image size when starting live view.



Set the volume when starting live view.



Note

If you adjust the volume when starting two-way audio, you may hear a repeated sounds.



You can capture image when starting live view.



Reserved function. You can zoom in the live view image.



Talk to the device.



Unlock the linked door.



Start or stop live view.



Start or stop video recording.



Select the streaming type when starting live view. You can select from the main stream and the sub stream.



Select the window division type when starting live view.



Full screen view.

7.4 Person Management

Click and add the person's information, including the basic information, authentication mode, card, and fingerprint. And you can also edit user information and search user information in the user list.

Add Basic Information

Click **User** → **Add** to enter the Add Person page.

Add the person's basic information, including the employee ID, the person's name, the gender, and the user role.

If you select **Visitor** as the user role, you can set the visit times.

Click **OK** to save the settings.

Set Permission Time

Click **User** → **Add** to enter the Add Person page.

Set **Start Time** and **End Time** and the person can only have the permission within the configured time period.

Click **OK** to save the settings.

Set Access Control

Click **User** → **Add** to enter the Add Person page.

After check **Administrator** in **Access Control**, the added person can log in the device by authentication.

Click **OK** to save the settings.

Set Room No.

Click **User** → **Add** to enter the Add Person page.

Click **Add** to add the **Floor No.** and **Room No.**

Click  to delete it.

Click **OK** to save the settings.

Add Authentication Mode

Click **User** → **Add** to enter the Add Person page.

Set the authentication type.

Click **OK** to save the settings.

Add Card

Click **User → Add** to enter the Add Person page.

Click **Add Card**, enter the **Card No.** and select the **Property**, and click **OK** to add the card.

Click **OK** to save the settings.

Add Fingerprint



Note

Only devices supporting the fingerprint function can add the fingerprint.

Click **User → Add** to enter the Add Person page.

Click **Add Fingerprint**, and press your finger on the fingerprint module of the device to add your fingerprint.

Click **Complete** to save the settings.

7.5 Search Event

Click **Search** to enter the Search page.

Event Types

Access Control Event 

Employee ID

Name

Card No.

Start Time

2022-05-27 00:00:00 

End Time

2022-05-27 23:59:59 

View Events with Recorded Video



Figure 7-2 Search Event

Enter the search conditions, including the event type, the employee ID, the name, the card No., the start time, and the end time, and click **Search**.

If you want to view events with recorded video, you can check **View Events with Recorded Video**.

- REC

The video is recording.

-  Play back the recorded video.
-  View the captured picture.

The results will be displayed on the right panel.

7.6 Device Management

You can manage the linked device on the page.

Steps

1. Click **Device Management** to enter the settings page.



Figure 7-3 Device Management

2. Click **Add** to add the indoor station or sub door station. Enter the parameters and click **OK** to add.
3. Click **Import**. Enter the information of the device in the template to import devices in batch.
4. Click **Export** to export the information to the PC.
5. Select the device and click **Delete** to remove the selected device from the list.
6. Click **Refresh** to get the device information.
7. **Optional:** Set Device Information.

Edit Device Information Click  to edit device information.

Delete Device Information Click  to delete device information from the list.

Search Devices Select **Status** and **Device Type** to search devices.

7.7 Configuration

7.7.1 Set Local Parameters

Set the live view parameters, record file saving path, and captured pictures saving path.

Set Live View Parameters

Click **Configuration** → **Local** to enter the Local page. Configure the stream type, the play performance, auto start live view, and the image format and click **Save**.

Set Record File Saving Path

Click **Configuration** → **Local** to enter the Local page. Select a record file size and select a saving path from your local computer and click **Save**.

You can also click **Open** to open the file folder to view details.

Set Captured Pictures Saving Path

Click **Configuration** → **Local** to enter the Local page. Select a saving path from your local computer and click **Save**.

You can also click **Open** to open the file folder to view details.

7.7.2 View Device Information

View the device name, bluetooth name, language, model, serial No., QR code, version, number of channels, IO input number, IO output number, local RS-485, register number, number of alarm output, device capacity, etc.

Click **Configuration** → **System** → **System Settings** → **Basic Information** to enter the configuration page.

You can view the device name, bluetooth name, language, model, serial No., QR code, version, number of channels, IO input number, IO output number, local RS-485, register number, number of alarm output, device capacity, etc.

7.7.3 Set Time

Set the device's time zone, synchronization mode, alarm receiver type, server address, NTP port, and interval.

Click **Configuration** → **System** → **System Settings** → **Time Settings** .

Time Zone (GMT+08:00) Beijing, Urumqi, Singapore, Perth

Timing mode NTP Manual

Alarm Receiver Type IPv4

Server Address 10.41.0.42

NTP Port 123

Interval 60 minute(s)

Figure 7-4 Time Settings

Click **Save** to save the settings after the configuration.

Time Zone

Select the device located time zone from the drop-down list.

Time Sync.

NTP

You should set the NTP server's IP address, port No., and interval.

Manual

By default, the device time should be synchronized manually. You can set the device time manually or check **Sync. with Computer Time** to synchronize the device time with the computer's time.

Server Address Type/Server Address/NTP Port/Interval

You can set the server address type, server address, NTP port, and interval.

7.7.4 Set DST

Steps

1. Click **Configuration** → **System** → **System Settings** → **DST** .

Enable DST

Start Time

End Time

DST Bias

Save

Figure 7-5 DST Page

2. Check **Enable DST**.
3. Set the DST start time, end time and bias time.
4. Click **Save** to save the settings.

7.7.5 View Open Source Software License

Go to **Configuration → System → System Settings → About Device** , and click **View Licenses** to view the device license.

7.7.6 Upgrade and Maintenance

Reboot device, restore device parameters, and upgrade device version.

Reboot Device

Click **Configuration → System → Maintenance → Upgrade & Maintenance** .
Click **Reboot** to start reboot the device.

Restore Parameters

Click **Configuration → System → Maintenance → Upgrade & Maintenance** .

Restore All

All parameters will be restored to the factory settings. You should activate the device before usage.

Default

The device will restore to the default settings, except for the device IP address and the user information.

Unlink APP Account

Unlink the Guarding Vision account from the platform.

Import and Export Parameters

Click **Configuration → System → Maintenance → Upgrade & Maintenance** .

Export

Click **Export** to export the logs or device parameters.



Note

You can import the exported device parameters to another device.

Import

Click  and select the file to import. Click **Import** to start import configuration file.

Upgrade

Click **Configuration → System → Maintenance → Upgrade & Maintenance** .

Select an upgrade type from the drop-down list. Click  and select the upgrade file from your local PC. Click **Upgrade** to start upgrading.

If the device has been connected to Guarding Vision and network, when there is a new installation package in Guarding Vision, you can click **Upgrade** after Online Update to upgrade the device system.



Note

Do not power off during the upgrading.

7.7.7 Log Query

You can search and view the device logs.

Go to **Configuration → System → Maintenance → Log Query** .

Set the major and minor type of the log type. Set the start time and end time for searching, and click **Search**.

The results will be displayed below, which including the No., time, the major type the minor type, the channel No., the local/remote user information, the remote host IP, etc.

7.7.8 Security Mode Settings

Set the security mode for logging in the client software.

On the Device for Management page, click **Configuration → System → Security → Security Service** .

Select a security mode from the drop-down list, and click **Save**.

Security Mode

High security level for user information verification when logging in the client software.

Compatible Mode

The user information verification is compatible with the old client software version when logging in.

Enable SSH

To raise network security, disable SSH service. The configuration is only used to debug the device for the professionals.

Enable HTTP

In order to increase the network security level when visiting websites, you can enable HTTP to acquire a more secure and encrypted network communication environment. The communication should be authenticated by identity and encryption password after enabling HTTP, which is safe.

7.7.9 Certificate Management

It helps to manage the server/client certificates and CA certificate.



Note

The function is only supported by certain device models.

Create and Install Self-signed Certificate

Steps

1. Go to **Configuration** → **System** → **Security** → **Certificate Management**.
2. In the **Certificate Files** area, select a **Certificate Type** from the drop-down list.
3. Click **Create**.
4. Input certificate information.
5. Click **OK** to save and install the certificate.

The created certificate is displayed in the **Certificate Details** area.

The certificate will be saved automatically.

6. Download the certificate and save it to an asking file in the local computer.
7. Send the asking file to a certification authority for signature.
8. Import the signed certificate.
 - 1) Select a certificate type in the **Import Passwords** area, and select a certificate from the local, and click **Install**.
 - 2) Select a certificate type in the **Import Communication Certificate** area, and select a certificate from the local, and click **Install**.

Install Other Authorized Certificate

If you already has an authorized certificate (not created by the device), you can import it to the device directly.

Steps

1. Go to **Configuration → System → Security → Certificate Management** .
2. In the **Import Passwords** and **Import Communication Certificate** areas, select certificate type and upload certificate.
3. Click **Install**.

Install CA Certificate

Before You Start

Prepare a CA certificate in advance.

Steps

1. Go to **Configuration → System → Security → Certificate Management** .
2. Create an ID in the **Import CA Certificate** area.



The input certificate ID cannot be the same as the existing ones.

3. Upload a certificate file from the local.
4. Click **Install**.

7.7.10 Change Administrator's Password

Steps

1. Click **Configuration → User Management** .
2. Click  .
3. Enter the old password and create a new password.
4. Confirm the new password.
5. Click **OK**.



The password strength of the device can be automatically checked. We highly recommend you change the password of your own choosing (using a minimum of 8 characters, including at least three kinds of following categories: upper case letters, lower case letters, numbers, and special characters) in order to increase the security of your product. And we recommend you change your password regularly, especially in the high security system, changing the password monthly or weekly can better protect your product.

Proper configuration of all passwords and other security settings is the responsibility of the installer and/or end-user.

7.7.11 View Device Arming/Disarming Information

View device arming type and arming IP address.

Go to **Configuration → Arming/Disarming Information** .

You can view the device arming/disarming information. Click **Refresh** to refresh the page.

7.7.12 Online Users

The information of users logging into the device is shown.

Go to **Configuration → System → User Management → Online Users** to view the list of online users.

7.7.13 Network Settings

Set TCP/IP, port, report strategy and platform access.

Set Basic Network Parameters

Click **Configuration → Network → Basic Settings → TCP/IP** .

DHCP	<input type="checkbox"/>
Network Card	Network Card1 <input type="button" value="v"/>
IPv4 Address	10.7.116.210
IPv4 Subnet Mask	255.255.255.0
IPv4 Default Gateway	10.7.116.254
IPv6 Mode	Route Advertisement <input type="button" value="v"/>
	<input type="button" value="View Route Advertisement"/>
IPv6 Address	2001:dddd::aeb9:2fff:fedf:8488
IPv6 Subnet Prefix Length	64
IPv6 Default Gateway	::
Mac Address	ac:b9:2f:df:84:88
MTU	1500
NIC Type	Auto <input type="button" value="v"/>
DNS Server	
DHCP	<input type="checkbox"/>
Preferred DNS Server	8.8.8.8
Alternate DNS Server	8.8.4.4

Figure 7-6 TCP/IP Settings Page

Set the parameters and click **Save** to save the settings.

DHCP

If uncheck the function, you should set the IPv4 address, IPv4 subnet mask, IPv4 default gateway, MTU, and the device port.

If you check the function, the system will allocate the IPv4 address, IPv4 subnet mask, and the IPv4 default gateway automatically.

NIC Type

Select a NIC type from the drop-down list. By default, it is **Auto**.

DNS Server

Set the preferred DNS server and the Alternate DNS server according to your actual need.

Set Port Parameters

Set the HTTP, RTSP, and HTTPS parameters.

Click **Configuration → Network → Basic Settings → Port** .

HTTP

It refers to the port through which the browser accesses the device. For example, when the HTTP Port is modified to 81, you need to enter ***http://192.0.0.65:81*** in the browser for login.

RTSP

It refers to the port of real-time streaming protocol.

HTTPS

Set the HTTPS for accessing the browser. Certificate is required when accessing.

Set Wi-Fi Parameters

Set the Wi-Fi parameters for device wireless connection.

Steps



The function should be supported by the device.

1. Click **Configuration → Network → Basic Settings → Wi-Fi** .



Figure 7-7 Wi-Fi Settings Page

2. Check **Wi-Fi**.
3. Select a Wi-Fi
 - Click 🔒 of a Wi-Fi in the list and enter the Wi-Fi password.
 - Click **Add** and enter a Wi-Fi's name, password, and encryption type. Click **Connect**. When the Wi-Fi is connected, click **OK**.
4. **Optional:** Set the WLAN parameters.
 - 1) Click **TCP/IP Settings**.
 - 2) Set the IP address, subnet mask, and default gateway. Or check **Enable DHCP** and the system will allocate the IP address, subnet mask, and default gateway automatically.
5. Click **Save**.

Configure SIP Parameters

Set the device's IP address and the SIP server's IP address. After setting the parameters, you can communicate among the access control device, door station, indoor station, main station, and the platform.

Note

Only the access control device and other devices or systems (such as door station, indoor station, main station, platform) are in the same IP segment, the two-way audio can be performed.

Go to **Configuration** → **Network** → **Basic Settings** → **SIP** .

Check **Enable VOIP Gateway**.

Set register user name, registration password, server address, expiry time, number, and display user name.

Click **Save**.

Report Strategy Settings

You can set the center group for uploading the log via the ISUP protocol.

Go to **Configuration → Network → Basic Settings → Report Strategy** .

You can set the center group and the system will transfer logs via ISUP protocol. Click **Save** to save the settings.

Center Group

Select a center group from the drop-down list.

Main Channel

The device will communicate with the center via the main channel.



Note

N1 refers to wired network.

Set ISUP Parameters

Set the ISUP parameters for accessing device via ISUP protocol.

Steps



Note

The function should be supported by the device.

1. Click **Configuration → Network → Advanced Settings → Platform** .
2. Select **ISUP** from the platform access mode drop-down list.
3. Check **Enable**.
4. Set the ISUP version, and view the alarm receiver type, server address, port, device ID, register status.



Note

If you select 5.0 as the version, you should set the ISUP key as well.

5. Set the ISUP listening parameters, including ISUP alarm center IP address/domain name, ISUP alarm center URL, and ISUP alarm center port.
6. Click **Save**.

Platform Access

Platform access provides you an option to manage the devices via platform.

Steps

1. Click **Configuration → Network → Advanced → Platform Access** to enter the settings page.

2. Select the **Platform Access Mode**.

Note

Guarding Vision is an application for mobile devices. With the App, you can view live image of the device, receive alarm notification and so on.

3. Check the checkbox of **Enable** to enable the function.

4. **Optional:** Check the checkbox of **Custom**, and you can set the server address by yourself.

5. Create a **Stream Encryption/Encryption Key** for the device.

Note

6 to 12 letters (a to z, A to Z) or numbers (0 to 9), case sensitive. You are recommended to use a combination of no less than 8 letters or numbers.

6. Click **Save** to enable the settings.

Configure HTTP Listening

The device can send alarm information to the event alarm IP address or domain name via HTTP protocol/HTTPS protocol.

Before You Start

The event alarm IP address or domain name should support the HTTP protocol/HTTPS protocol to receive the alarm information.

Note

The function should be supported by the device.

Steps

1. Click **Configuration** → **Network** → **Advanced** → **HTTP Listening** .

2. Edit the event alarm IP address or domain name, URL, port, and protocol.

3. **Optional:** Click **Default** to reset the event alarm IP address or domain name.

4. Click **Save**.

7.7.14 Set Video and Audio Parameters

Set the image quality, resolution, and the device volume.

Set Video Parameters

Click **Configuration** → **Video/Audio** → **Video** .

Set the video channel, camera name, stream type, the video type, the bitrate type, the frame rate, the Max. bitrate, the video encoding, and I Frame Interval.

Click **Save** to save the settings after the configuration.

Set Audio Parameters

Click **Configuration** → **Video/Audio** → **Audio** .

Select the audio channel.

Select the stream type and audio encoding.

You can also drag the block to adjust the device input and output volume.

Click to enable **Voice Prompt**.

Click **Save** to save the settings after the configuration.



Note

The functions vary according to different models. Refers to the actual device for details.

7.7.15 Set Image Parameters

Set the video standard, WDR, image adjustment, and supplement light.

Steps

1. Click **Configuration** → **Image** .
2. Configure the parameters to adjust the image.

Video Standard

Set the video frame rate when performing live view remotely. After changing the standard, you should reboot the device to take effect.

PAL

25 frames per second. Suitable for mainland China, Hong Kong (China), the Middle East countries, Europe countries, etc.

NTSC

30 frames per second. Suitable for the USA, Canada, Japan, Taiwan (China), Korea, the Philippines, etc.

WDR

Enable or disable the WDR function.

When there are both very bright and very dark areas simultaneously in the view, WDR balances the brightness level of the whole image and provide clear images with details.

Brightness/Contrast/Saturation/Sharpness

Drag the block or enter the value to adjust the live video's brightness, contrast, saturation, and sharpness.

Supplement Light Parameters

Set the supplement light type from the drop down list and select to enable or disable it.

If you select **On**, you can set the light brightness.

If you select **Schedule**, you can set the light brightness and its schedule.



Start/end recording video.



Capture the image.

3. Click **Default** to restore the parameters to the default settings.

7.7.16 Event Linkage

Set linked actions for events.

Steps

1. Click **Configuration** → **Event** → **Basic Event** → **Event Linkage** to enter the page.
2. Set event source.
 - If you choose **Linkage Type** as **Event Linkage**, you need to select event types from the drop-down list.
 - If you choose **Linkage Type** as **Card Linkage**, you need to enter the card No. and select the card reader.
 - If you choose **Linkage Type** as **Employee ID Linkage**, you need to enter the employee ID and select the card reader.
3. Set linked action.

Linked Door

Enable **Linked Door**, check **Door 1** or **Door 2**, and set the door status for the target event.

Linked Alarm Output

Enable **Linked Alarm Output**, check **Alarm Output 1** or **Alarm Output 2**, and set the alarm output status for the target event.

Capture Linkage

Enable **Capture Linkage** and select the card reader to capture for the target event.

Trigger Recording

Enable **Trigger Recording**. Click **Configuration** → **Event** → **Basic Event** → **Recording** → , you can enable **Record Audio When Recording**, and set **Pre-record** and **Post-record** time.



Note

Equip the device with an SD card to use video recording function. To view the recorded videos, see ***Search Event*** .

7.7.17 General Settings

Set Authentication Parameters

Click **Configuration** → **General** → **Authentication Settings** .



The functions vary according to different models. Refers to the actual device for details.

Click **Save** to save the settings after the configuration.

Card Reader

Select **Main Card Reader** or **Sub Card Reader** from the drop-down list.

Main Card Reader

You can configure the device card reader's parameters.

Sub Card Reader

You can configure the connected peripheral card reader's parameters.

If select **Main Card Reader**:

Card Reader Type/Card Reader Description

Get card reader type and description. They are read-only.

Enable Card Reader

Enable the card reader's function.

Authentication

Select an authentication mode according to your actual needs from the drop-down list.

Multiple People Authentication

Multiple people can be authenticated at the same time.

Recognition Interval

You can set the interval between 2 continuous recognition of a same person during the authentication. In the configured interval, Person A can only recognized once. If another person (Person B) has recognized during the interval, Person A can recognized again.

Authentication Interval

You can set the authentication interval of the same person when authenticating. The same person can only authenticate once in the configured interval. A second authentication will be failed.

Alarm of Max. Failed Attempts

Enable to report alarm when the card reading attempts reach the set value.

Max. Authentication Failed Attempts

Enable to report alarm when the card reading attempts reach the set value.

Enable Tampering Detection

Enable the anti-tamper detection for the card reader.

Enable Card No. Reversing

The read card No. will be in reverse sequence after enabling the function.

Open Door via Bluetooth

The door can open via bluetooth after enabling the function.

If select **Sub Card Reader**:

Card Reader Type/Card Reader Description

Get card reader type and description. They are read-only.

Enable Card Reader

Enable the card reader's function.

Authentication

Select an authentication mode according to your actual needs from the drop-down list.

Multiple People Authentication

Multiple people can be authenticated at the same time.

Recognition Interval

If the interval between card presenting of the same card is less than the configured value, the card presenting is invalid.

Alarm of Max. Failed Attempts

Enable to report alarm when the card reading attempts reach the set value.

Max. Authentication Failed Attempts

Enable to report alarm when the card reading attempts reach the set value.

Communication with Controller Every

When the access control device cannot connect with the card reader for longer than the set time, the card reader will turn offline automatically.

Max. Interval When Entering Password

When you entering the password on the card reader, if the interval between pressing two digits is longer than the set value, the digits you pressed before will be cleared automatically.

OK LED Polarity/Error LED Polarity

Set OK LED Polarity/Error LED Polarity of the access control device according to the card reader parameters. Generally, adopts the default settings.

Enable Tampering Detection

Enable the anti-tamper detection for the card reader.

Open Door via Bluetooth

The door can open via bluetooth in Guarding Vision after enabling the function.

Set Privacy Parameters

Set the event storage type, picture upload and storage parameters, and the picture clearing parameters.

Go to **Configuration → General → Privacy**

Event Storage Settings

Select a method to delete the event. You can select from **Delete Old Events Periodically**, **Delete Old Events by Specified Time**, or **Overwriting**.

Delete Old Events Periodically

Drag the block or enter number to set the period for event deleting. All events will be deleted according to the configured time duration.

Delete Old Events by Specified Time

Set a time and all events will be deleted on the configured time.

Overwriting

The earliest 5% events will be deleted when the system detects the stored events has been over 95% of the full space.

Picture Uploading and Storage

Upload Picture After Linked Capture

Upload the pictures captured by linked camera to the platform automatically.

Save Pictures After Linked Capture

If you enable this function, you can save the picture captured by linked camera to the device.

Clear All Pictures in Device



Note

All pictures cannot be restored once they are deleted.

Clear Captured Pictures

All captured pictures in the device will be deleted.

Set Face Recognition Parameters

You can set face recognition parameters for accessing.

Click **Configuration → General → Face Recognition Parameters** .

You can set **Working Mode** as **Access Control Mode**. The access control mode is the device normal mode. You should authenticate your credential for accessing.

Click **Save** to save the settings after the configuration.

Set Card Security

Click **Configuration** → **General** → **Card Security** to enter the settings page.

Set the parameters and click **Save**.

Enable NFC Card

In order to prevent the mobile phone from getting the data of the access control, you can enable NFC card to increase the security level of the data.

Enable M1 Card

Enable M1 card and authenticating by presenting M1 card is available.

M1 Card Encryption

Sector

M1 card encryption can improve the security level of authentication.

Enable the function and set the encryption sector. By default, Sector 13 is encrypted. It is recommended to encrypt sector 13.

Enable EM Card

Enable EM card and authenticating by presenting EM card is available.



Note

EM card is supported when the device connects a peripheral card reader that supports presenting EM card.

Enable DESFire Card

The device can read the data from DESFire card when enabling the DESFire card function.

DESFire Card Read Content

After enable the DESFire card content reading function, the device can read the DESFire card content.

Set Card Authentication Parameters

Set the card reading content when authenticate via card on the device.

Go to **Configuration** → **General** → **Card Authentication Settings** .

Select a card authentication mode and click **Save**.

Full Card No.

All card No. will be read.

Wiegand 26 (3 bytes)

The device will read card via Wiegand 26 protocol (read 3 bytes).

Wiegand 34 (4 bytes)

The device will read card via Wiegand 34 protocol (read 4 bytes).

7.7.18 Access Control Settings

Set Door Parameters

Click **Configuration** → **Access Control** → **Door Parameters** .

Door No.

Name

Open Duration s

Door Open Timeout Alarm s

Door Contact Remain Closed Remain Open

Exit Button Type Remain Closed Remain Open

Door Lock Powering Off Remain Closed Remain Open

Extended Open Duration s

Door Remain Open Duration with First Person m

Duress Code
Enter 0 to 8 digits.

Super Password
Enter 0 to 8 digits.

Figure 7-8 Door Parameters Settings Page

Click **Save** to save the settings after the configuration.

Door No.

Select the device corresponded door No.

Name

You can create a name for the door.

Open Duration

Set the door unlocking duration. If the door is not opened for the set time, the door will be locked.

Door Open Timeout Alarm

An alarm will be triggered if the door has not been closed within the configured time duration.

Door Contact

You can set the door contact as **Remain Open** or **Remain Closed** according to your actual needs. By default, it is **Remain Closed**.

Exit Button Type

You can set the exit button as **Remain Open** or **Remain Closed** according to your actual needs. By default, it is **Remain Open**.

Door Lock Powering Off Status

You can set the door lock status when the door lock is powering off. By default, it is **Remain Closed**.

Extended Open Duration

The door contact can be enabled with appropriate delay after person with extended access needs swipes her/his card.

Door Remain Open Duration with First Person

Set the door open duration when first person is in. After the first person is authorized, it allows multiple persons access the door or other authentication actions.

Duress Code

The door can open by inputting the duress code when there is duress. At the same time, the client can report the duress event.

Super Password

The specific person can open the door by inputting the super password.



Note

The duress code and the super code should be different.

Elevator Control

Steps

1. Click **Configuration** → **Access Control** → **Elevator Control Parameters** .
2. Check **Enable Elevator Control**.
3. Set the elevator parameters.

Elevator No.

Select an elevator No. for configuration from the drop-down list.

Elevator Controller Type

Select an elevator controller from the drop-down list.

Interface Type

Select a communication type from the drop-down list for elevator communication.

If you select **RS-485**, make sure you have connected the device to the elevator controller with RS-485 wire.

If you select **Network Interface**, enter the elevator controller's IP address, port No., user name, and password for communication.

Negative Floor Capacity

Set the negative floor number.



Note

- Up to 4 elevator controllers can be connected to 1 device.
 - Up to 10 negative floors can be added.
 - Make sure the interface types of elevator controllers, which are connected to the same device, are consistent.
-

Set RS-485 Parameters

You can set the RS-485 parameters including the peripheral, address, baud rate, etc.

Click **Configuration** → **Access Control** → **RS-485 Settings** .

Check **Enable RS-485**, and set the parameters.

Click **Save** to save the settings after the configuration.

No.

Set the RS-485 No.

Peripheral Type

Select a peripheral from the drop-down list according the actual situation. You can select from **Card Reader**, **Extension Module**, **Access Controller**, or **Disable**.

Note

After the peripheral is changed and saved, the device will reboot automatically.

RS-485 Address

Set the RS-485 Address according to your actual needs.

Note

If you select **Access Controller**: If connect the device to a terminal via the RS-485 interface, set the RS-485 address as 2. If you connect the device to a controller, set the RS-485 address according to the door No.

Baud Rate

The baud rate when the devices are communicating via the RS-485 protocol.

Set Wiegand Parameters

You can set the Wiegand transmission direction.

Steps

Note

Some device models do not support this function. Refer to the actual products when configuration.

1. Click **Configuration** → **Access Control** → **Wiegand Settings** .

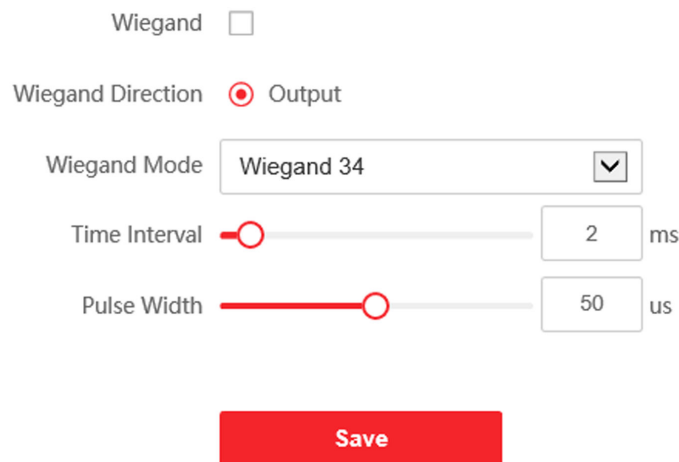

Wiegand

Wiegand Direction Output

Wiegand Mode

Time Interval ms

Pulse Width us

Save

Figure 7-9 Wiegand Page

2. Check **Wiegand** to enable the Wiegand function.
3. Set a transmission direction.

Input

The device can connect a Wiegand card reader.

Output

The can connect an external access controller. And the two devices will transmit the card No. via Wiegand 26 or 34.

4. Drag the block to set the time interval and pulse width.
-

Note

- The time interval ranges from 1 ms to 20 ms.
 - The pulse width ranges from 1 us to 100 us.
-

5. Click **Save** to save the settings.
-

Note

If you change the peripheral, and after you save the device parameters, the device will reboot automatically.

7.7.19 Video Intercom Settings

Set Video Intercom Parameters

The device can be used as a door station, outer door station, or access control device. You should set the device No. before usage.

Click **Configuration** → **Intercom** → **Device No.** .

If set the device type as **Door Station** or **Access Control Device**, you can set the floor No., door station No., and click **Advanced Settings** to set **Community No.**, **Building No.**, and **Unit No.**

Click **Save** to save the settings after the configuration.

Device Type

The device can be used as a door station or outer door station. Select a device type from the drop-down list.

Note

If you change the device type, you should reboot the device.

Floor No.

Set the device installed floor No.

Door Station No.

Set the device installed floor No.

Note

- If you change the No., you should reboot the device.
 - The main door station No. is 0, and the sub door station No. ranges from 1 to 16.
-

Community No.

Set the device community No.

Building No.

Set the device building No.

Unit No.

Set the device unit No.

Note

If you change the No., you should reboot the device.

If set the device type as **Outer Door Station**, you can set the period No., outer door station No., and community No.

Outer Door Station No.

If you select outer door station as the device type, you should enter a number between **1** and **99**.

Note

If you change the No., you should reboot the device.

Community No.

Set the device community No.

Session Settings

Enable the communication between door station, main station, and video intercom server.

Steps

1. Click **Configuration** → **Intercom** → **Session Settings** to enter the settings page.
2. Set registration password, main station IP, private server IP and enable Protocol 1.0.

Registration Password

Activation password of the main station.

Main Station IP

IP address of the main station.

Private Server IP

IP address of the private server.

Enable Protocol 1.0

After enabling, the device is registered to the main station through the previous protocol. If disabled, the device is registered to the main station through the new protocol.

3. Click **Save**.

Time Duration Settings

Set the Max. call duration.

Go to **Configuration → Intercom → Time Parameters** .

Drag the block to set the Max. call duration. Click **Save**.



Note

The Max. call duration range is 90 s to 120 s.

Number Settings

You can call the room SIP to call the room.

Steps

1. Click **Configuration → Intercom → Number Settings** to enter the settings page.
2. Click **+ Add**, enter the **Room No.** and **SIP**.
3. Click **Save**.

7.7.20 Set Basic Parameters

Set Basic Parameters

Click **Configuration → Smart → Smart** .

Select **Fingerprint Security Level** according to your actual needs.

Chapter 8 Configure the Device via the Mobile Browser

8.1 Login

You can login via mobile browser.



- Parts of the model supports Wi-Fi settings.
- Make sure the device is activated.

Obtain the IP address from the device after Wi-Fi is enabled. Make sure the IP segment of the device and the computer is the same. For details, refers to ***Set Wi-Fi Parameters*** .

Enter the device IP address in the address bar of the mobile browser and press **Enter** to enter the login page.

Enter the device user name and the password. Click **Login**.

8.2 Search Event

Click **Search** to enter the Search page.

Enter the search conditions, including the employee ID, the name, the card No., the start time, and the end time, and click **Search**.



Support searching for names within 32 digits.

The results will be displayed in the list.

8.3 User Management

You can add, edit, delete, and search users via mobile Web browser.

Steps

1. Tap **User** to enter the settings page.
2. Add user.
 - 1) Tap+.

Basic Information	
*Employee ID	
Name	
Gender	unknown >
User Role	Normal User >
Floor No.	
Room No.	
Card No.	0 >
Fingerprint	0 >
Long-Term Effective <input type="checkbox"/>	
Start Date	2022-07-18 >
End Date	2032-07-17 >
Administrator <input type="checkbox"/>	
Authentication Settings	

Figure 8-1 Add User

2) Set the following parameters.

Employee ID

Enter the employee ID. The Employee ID cannot be 0 or exceed 32 characters. It can be a combination of uppercase, lowercase letters and numbers.

Name

Enter your name. The name supports numbers, uppercase and lowercase English, and characters. The name is recommended to be within 32 characters.

Gender

Select the gender.

User Role

Select your user role.

Floor No./Room No./Card No.

Enter the floor No./room No/card No.

Fingerprint

Add fingerprint. Tap **Fingerprint**, then tap **+**, and add fingerprint via the fingerprint module.

Long-Term Effective

Set the user permission as long-term effective.

Start Date/End Date

Set **Start Date** and **End Date** of user permission.

Administrator

If the user needs to be set as administrator, you can enable **Administrator**.

Authentication Type

Set the authentication type.

3) Tap **Save**.

3. Tap the user that needs to be edited in the user list to edit the information.
4. Tap the user that needs to be deleted in the user list, and tap  to delete the user.
5. You can search the user by entering the employee ID or name in the search bar.

8.4 Configuration

8.4.1 View Device Information

View the device name, language, model, serial No., QR code, version, etc.

Tap **Configuration** → **System** → **System Settings** → **Basic Information** to enter the configuration page.

You can view the device name, language, model, serial No., QR code, version, etc.

8.4.2 Time Settings

Set the time zone, time sync. mode, and displayed time.

Tap **Configuration** → **System** → **System Settings** → **Time Settings** to enter the settings page.

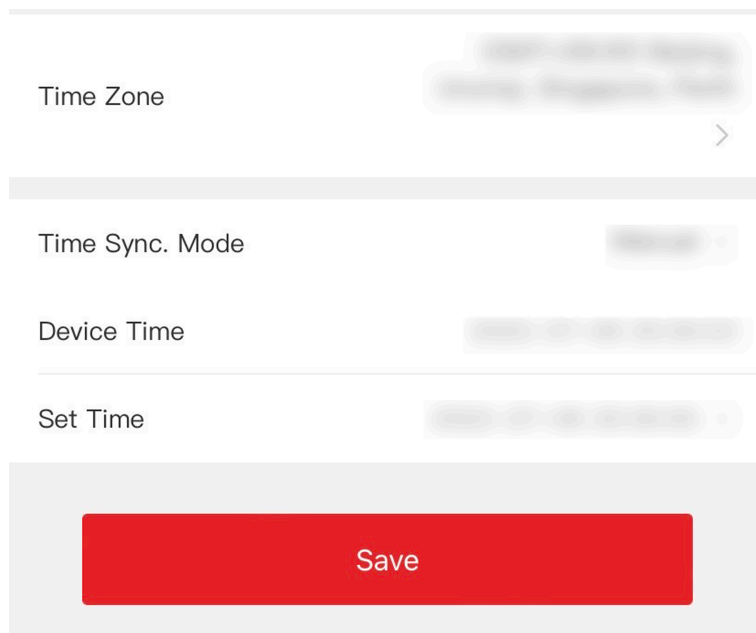

Figure 8-2 Time Settings

Tap **Save** to save the settings.

Time Zone

Select the time zone where the device is located from the drop-down list.

Time Sync. Mode

Manual

By default, the device time should be synchronized manually. You can set the device time manually.

NTP

Set the NTP server's IP address, port No., and interval.

8.4.3 Set DST

Steps

1. Tap **Configuration** → **System** → **System Settings** → **DST** , to enter the settings page.

Enable DST

Start Time Apr First Sunday 02h

Month Apr >

Week First >

Weekday Sunday >

Time 02 >

End Time Oct Last Sunday 02h

Month Oct >

Week Last >

Weekday Sunday >

DST Bias 30minute(s) >

Save

Figure 8-3 DST

2. Tap **Enable DST**.
3. Set the start time, end time, and DST bias.
4. Tap **Save**.

8.4.4 View Open Source Software License

Tap **Configuration** → **System** → **System Settings** → **About** , and tap **View Licenses** to view the device license.

8.4.5 User Management

Steps

1. Tap **Configuration** → **System** → **User Management** → **admin** → **Modify Password** to enter the setting page.
2. Enter the old password and create a new password.
3. Confirm the new password.
4. Tap **OK**.

Note

The password strength of the device can be automatically checked. We highly recommend you change the password of your own choosing (using 8-16 characters, including at least two kinds of following categories: upper case letters, lower case letters, numbers, and special characters) in order to increase the security of your product. And we recommend you change your password regularly, especially in the high security system, changing the password monthly or weekly can better protect your product.

8.4.6 Upgrade and Maintenance

Reboot device, restore device parameters, upgrade device version and unlink the app.

Reboot Device

Tap **Configuration** → **System** → **Maintenance** .
Tap **Reboot** to reboot the device.

Upgrade

Tap **Configuration** → **System** → **Maintenance** .
If the device has been connected to Guarding Vision and network, when there is a new installation package in Guarding Vision, you can tap **Upgrade** after Online Update to upgrade the device system.

Note

Do not power off during the upgrading.

Restore Parameters

Tap **Configuration** → **System** → **Maintenance** .

Default

The device will restore to the default settings, except for the device IP address and the user information.

Restore All

All parameters will be restored to the factory settings. You should activate the device before usage.

Unlink

Tap **Configuration** → **System** → **Maintenance** .

Tap **Unlink** to unlink the app.

After unlinking APP account, you cannot operate via APP.

8.4.7 Security Settings

You can set the SSH and HTTP according to actual needs.

Tap **Configuration** → **System** → **Security** , to enter the settings page.

Check **Enable** to enable SSH.

Check **Enable** to enable HTTP.

8.4.8 Network Settings

You can set the port and Wi-Fi parameters.

Set Wi-Fi Parameters

Set the Wi-Fi parameters for device wireless connection.

Steps



The function should be supported by the device.

1. Tap **Configuration** → **Network** → **Basic Settings** → **Wi-Fi** to enter the settings page.
2. Check **Enable Wi-Fi**.

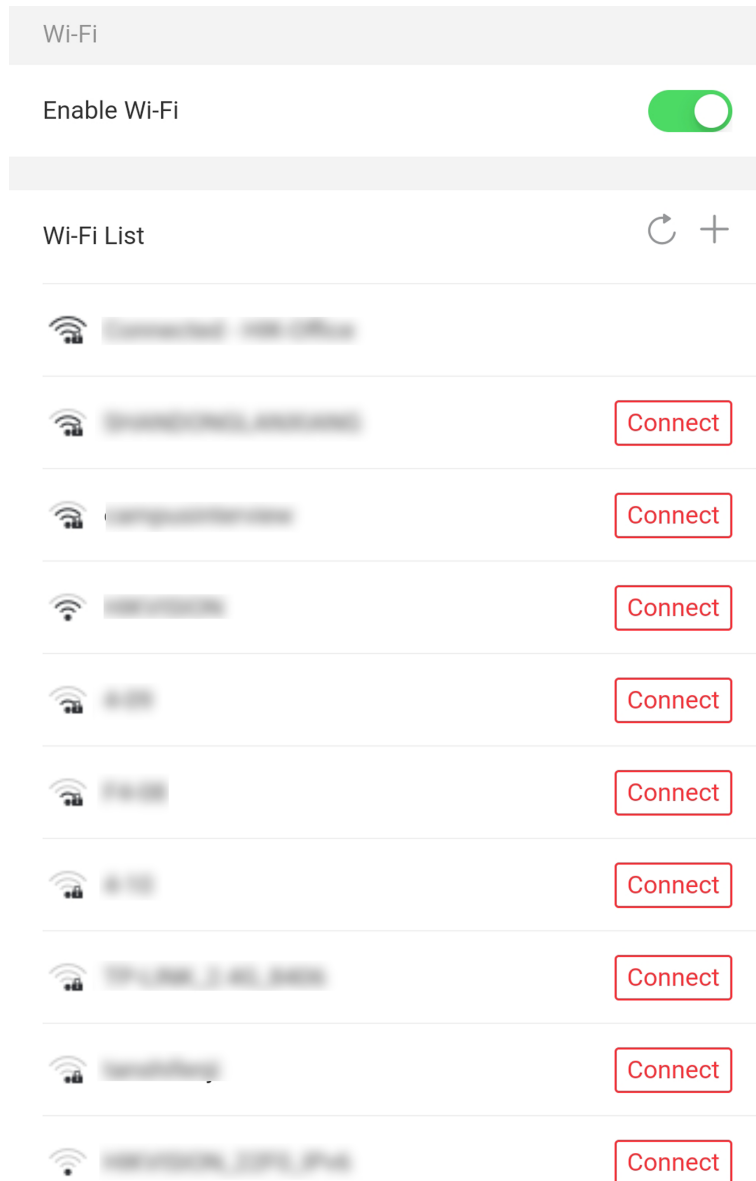

Figure 8-4 Wi-Fi

- 3. Add Wi-Fi.
 - 1) Tap +.

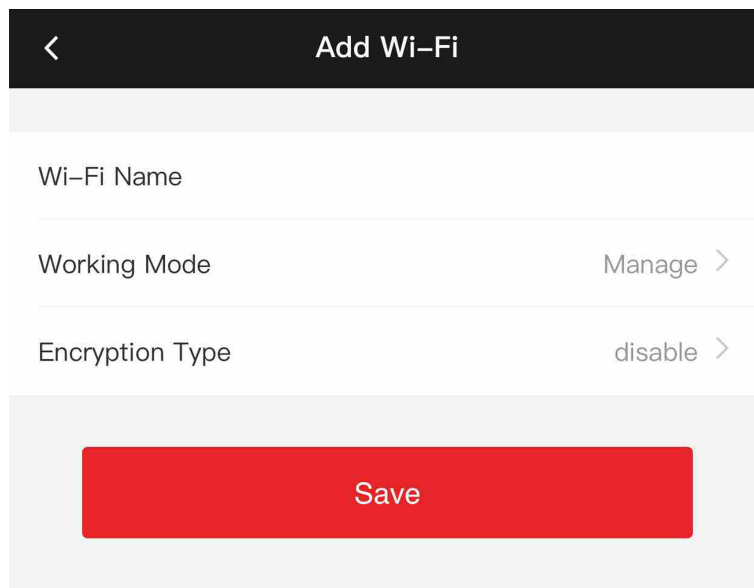

Figure 8-5 Add Wi-Fi

- 2) Enter **Wi-Fi Name** and **Wi-Fi Password**, and select **Working Mode** and **Encryption Type**.
- 3) Tap **Save**.
4. Select the Wi-Fi name, and tap **Connect**.
5. Enter the password and tap **Save**.
6. Set WLAN parameters.
 - 1) Set the IP address, subnet mask, and gateway. Or enable DHCP and the system will allocate the IP address, subnet mask, and gateway automatically.
 - 2) Tap **Save**.

Set Port Parameters

You can set the HTTP, RTSP, and HTTPS according to actual needs when accessing the device via network.

Tap **Configuration** → **Network** → **Basic Settings** → **Port** , to enter the setting page.

HTTP

It refers to the port through which the browser accesses the device. For example, when the HTTP Port is modified to 81, you need to enter **http://192.0.0.65:81** in the browser for login.

RTSP

It refers to the port of real-time streaming protocol.

HTTPS

Set the HTTPS for accessing the browser. Certificate is required when accessing.

Platform Access

Platform access provides you an option to manage the devices via platform.

Steps

1. Tap **Configuration** → **Network** → **Advanced** → **Guarding Vision** to enter the settings page.
-



Guarding Vision is an application for mobile devices. With the App, you can view live image of the device, receive alarm notification and so on.

2. Check **Enable** to enable the function.
 3. Enter the server address and stream encryption.
-



6 to 12 letters (a to z, A to Z) or numbers (0 to 9), case sensitive. You are recommended to use a combination of no less than 8 letters or numbers.

4. You can view **Register Status** and **Device QR Code**.
 5. Tap **Save** to enable the settings.
-

Set ISUP Parameters

Set the ISUP parameters for accessing device via ISUP protocol.

Steps



The function should be supported by the device.

1. Tap **Configuration** → **Network** → **Advanced** → **ISUP** .
 2. Check **Enable**.
 3. Set the ISUP version, IP Address, Port, and Account.
-



If you select 5.0 as the version, you should set the encryption key as well.

4. Set the Center Group.

Center Group

Select a center group from the drop-down list.

Main Channel/Backup Channel

The device will communicate with the center via the main channel. When exception occurs in the main channel, the device and the center will communicate with each other via the backup channel.

5. Tap **Save** to save the settings.
-

HTTP Listening

You can set the HTTP listening parameters.

Steps

1. Tap **Configuration** → **Network** → **Advanced** → **HTTP Listening** .
2. Edit the destination IP or domain name, URL and port.
3. **Optional:** Tap **Default** to reset the destination IP or domain name.
4. Tap **Save**.

8.4.9 General Settings

Set Authentication Parameters

Set Authentication Parameters.

Steps

1. Tap **Configuration** → **General Settings** → **Authentication Settings** .

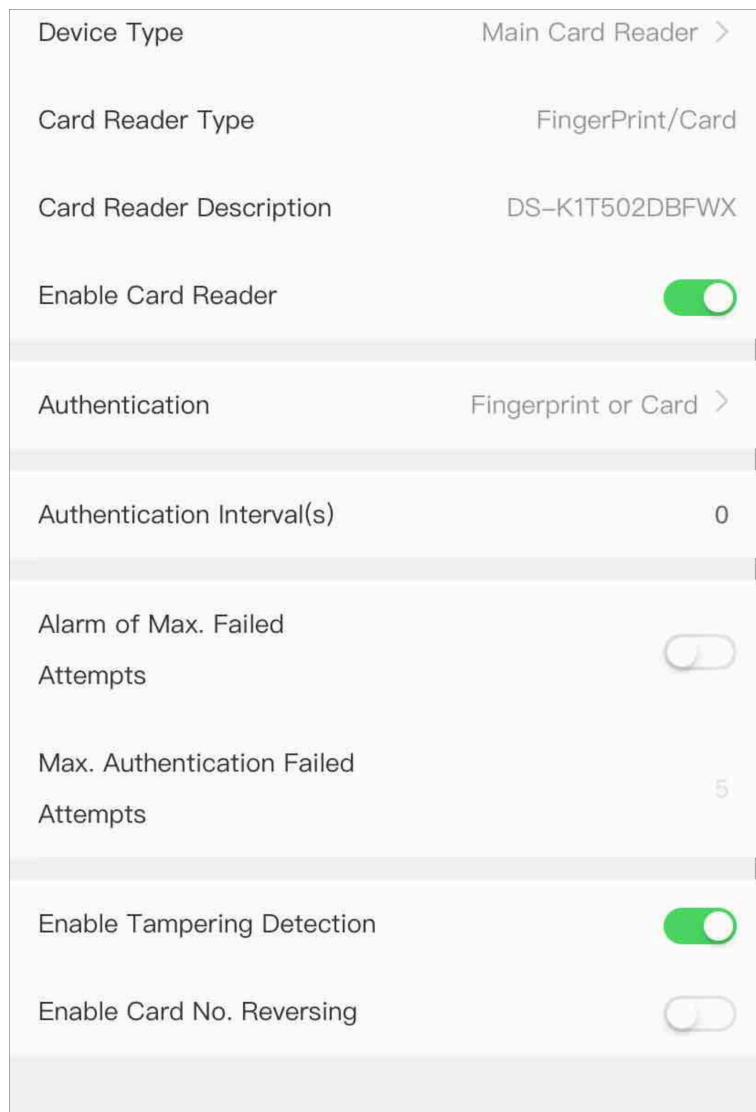

Figure 8-6 Authentication Settings

2. Tap Save.

Device Type

Main Card Reader

You can configure the device card reader's parameters. If you select main card reader, you need to configure the following parameters: **Card Reader Type**, **Card Reader Description**, **Enable Card Reader**, **Authentication**, **Recognition Interval (s)**, **Minimum Card Swiping Interval (s)**, **Max. Authentication Failed Attempts Alarm/Alarm of Max. Failed Attempts**, **Enable Tampering Detection** and **Enable Card No. Reversing**.

Card Reader Type

Get card reader type.

Card Reader Description

Get card reader description. It is read-only.

Enable Card Reader

Enable the card reader's function.

Authentication

Select an authentication mode according to your actual needs from the drop-down list.

Authentication Interval

You can set the authentication interval of the same person when authenticating. The same person can only authenticate once in the configured interval. A second authentication will be failed.

Max. Authentication Failed Attempts Alarm/Alarm of Max. Failed Attempts

Enable to report alarm when the card reading attempts reach the set value.

Enable Tampering Detection

Enable the anti-tamper detection for the card reader.

Enable Card No. Reversing

The card No. will be in reverse sequence after enabling the function.

Set Privacy Parameters

Set the event storage type.

Tap **Configuration** → **General Settings** → **Privacy** .

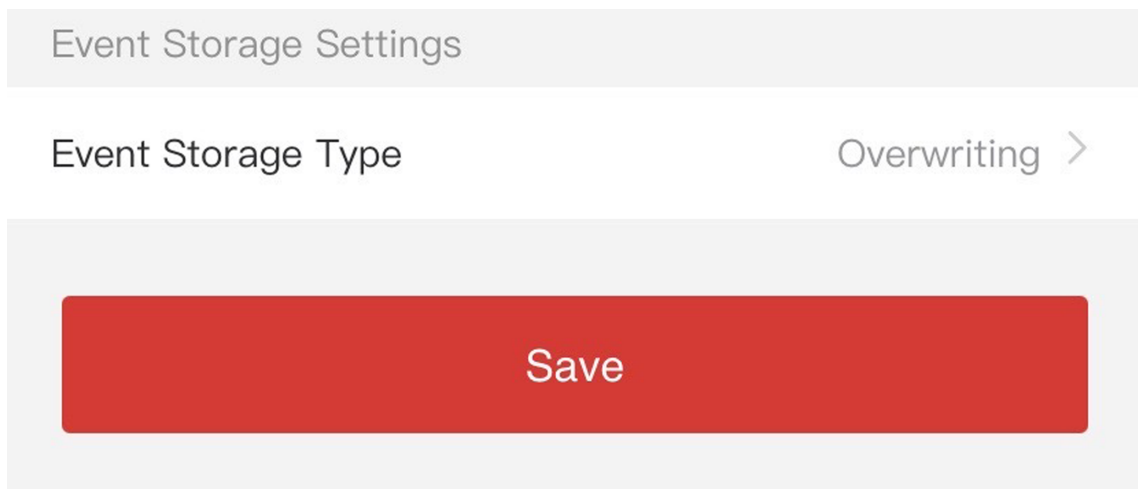

Figure 8-7 Privacy Settings

Event Storage Settings

Select a method to delete the event. You can select from **Delete Old Events Periodically**, **Delete Old Events by Specified Time**, or **Overwriting**.

Delete Old Events Periodically

Enter number to set the period for event deleting. All events will be deleted according to the configured time duration.

Delete Old Events by Specified Time

Set a time and all events will be deleted on the configured time.

Overwriting

The earliest 5% events will be deleted when the system detects the stored events has been over 95% of the full space.

Set Card Security

Tap **Configuration** → **General Settings** → **Card Security** to enter the settings page.

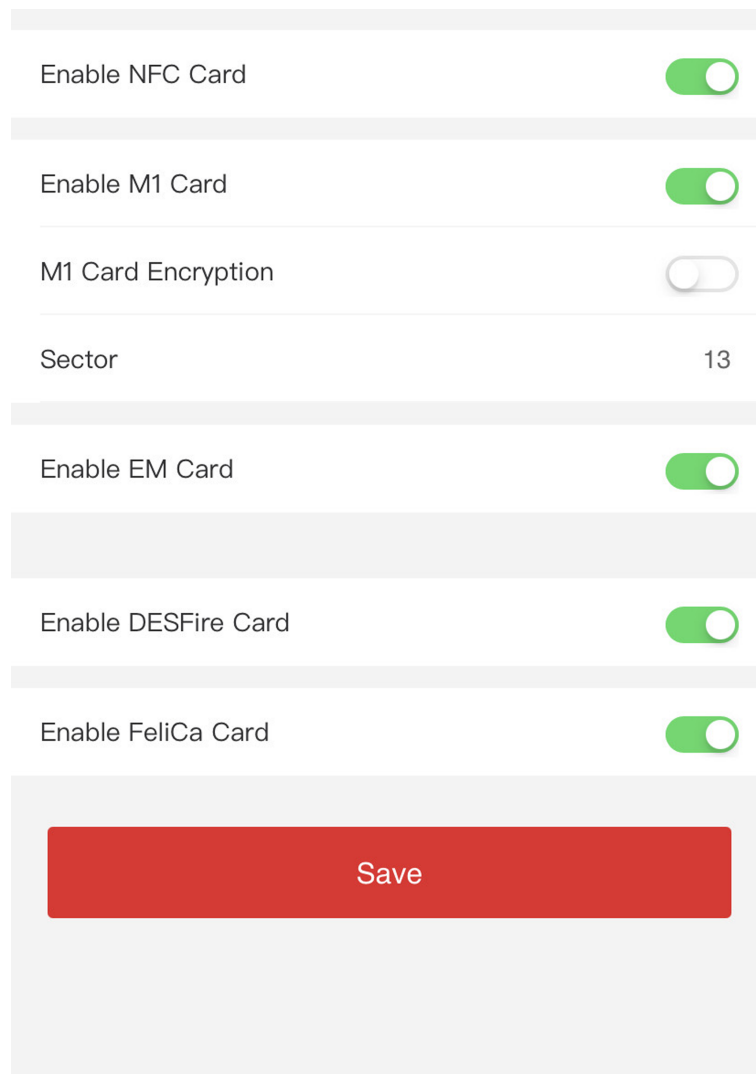

Figure 8-8 Card Security

Set the parameters and tap **Save**.

Enable NFC Card

In order to prevent the mobile phone from getting the data of the access control, you can enable NFC card to increase the security level of the data.

Enable M1 Card

Enable M1 card and authenticating by presenting M1 card is available.

M1 Card Encryption

M1 card encryption can improve the security level of authentication.

Sector

Enable the function and set the encryption sector. By default, Sector 13 is encrypted. It is recommended to encrypt sector 13.

Enable EM Card

Enable EM card and authenticating by presenting EM card is available.



Note

EM card is supported when the device connects a peripheral card reader that supports presenting EM card.

Enable DESFire Card

The device can read the data from DESFire card when enabling the DESFire card function.

Set Card Authentication Parameters

Set the card reading content when authenticate via card on the device.

Tap **Configuration** → **General Settings** → **Card Authentication Settings** .

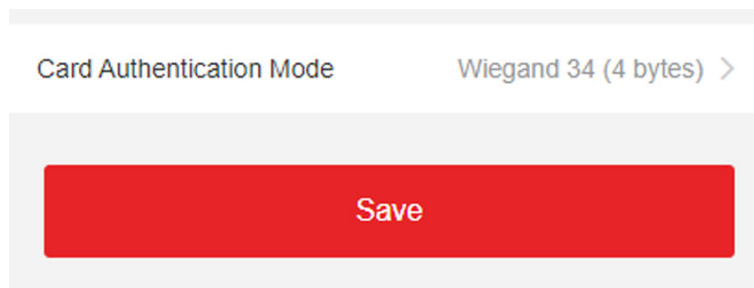

Figure 8-9 Card Authentication Page

Select a card authentication mode and tap **Save**.

Full Card No.

All card No. will be read.

Wiegand 26 (3 bytes)

The device will read card via Wiegand 26 protocol (read 3 bytes).

Wiegand 34 (4 bytes)

The device will read card via Wiegand 34 protocol (read 4 bytes).

8.4.10 Face Parameters Settings

Set fingerprint security level.

Tap **Configuration** → **Smart** → **Intelligent Parameter** .

Fingerprint Security Level 5-1/100000False
Acceptance Rate (FAR)

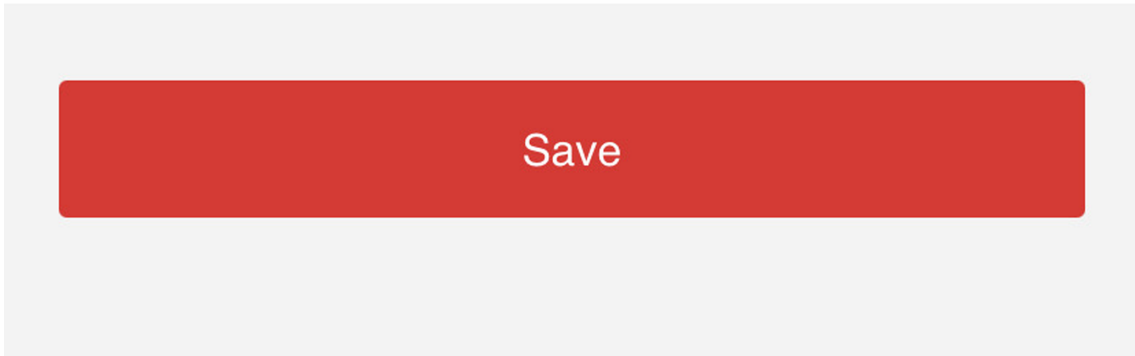

Figure 8-10 Fingerprint Security Level



Note

The functions vary according to different models. Refers to the actual device for details.

Select the security level according to actual needs. Tap **Save** to save the settings.

8.4.11 Video Intercom Settings

Set Device ID

The device can be used as a door station, outer door station, or access control device. You should set the device ID before usage.

Device ID Settings

Tap **Configuration** → **Intercom** → **Device ID Settings** .

If you set the device type as **Door Station**, you can set the floor No. and door station No.

Tap **Save** to save the settings after the configuration.

The screenshot shows a configuration interface for a door station. It features three rows of settings, each with a label on the left and a value on the right. The first row is 'Device Type' with the value 'Door Station' and a right-pointing chevron. The second row is 'Floor No.' with the value '1' and a right-pointing chevron. The third row is 'Door Station No.' with the value '0'. Below these settings is a large red button with the word 'Save' in white text.

Figure 8-11 Device ID Settings (Door Station)

Device Type

The device can be used as a door station, or outer door station. Select a device type from the drop-down list.

 **Note**

If you change the device type, you should reboot the device.

Floor No.

Set the device installed floor No.

Door Station No.

Set the device installed floor No.

 **Note**

If you change the No., you should reboot the device.

If you set the device type as **Outer Door Station**, you can set the outer door station No.

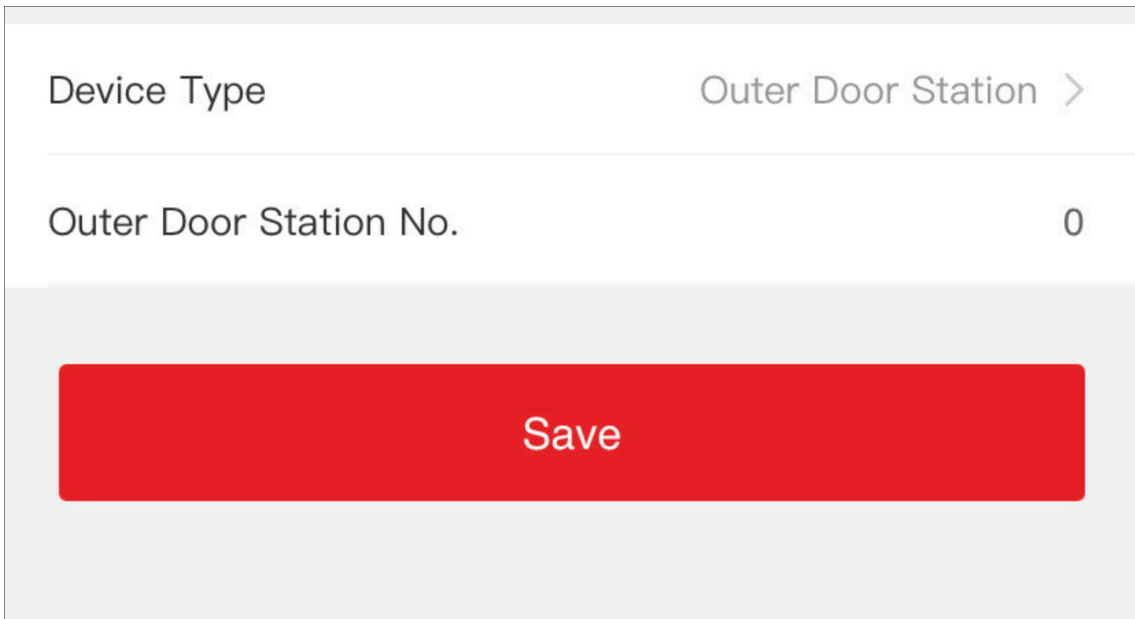

Figure 8-12 Device ID Settings (Outer Door Station)

Outer Door Station No.

If you select outer door station as the device type, you should enter a number between **1** and **99**.

 **Note**

If you change the No., you should reboot the device.

8.4.12 Access Control Settings

Set Door Parameters

Tap **Configuration** → **Access Control** → **Door Parameters** .

Door No.	Door1 >
Name	door1
Open Duration(s)	5
Door Open Timeout Alarm(s)	30
Door Contact	Remain Closed >
Exit Button Type	Remain Open >
Extended Open Duration(s)	15
Door Remain Open Duration with First Person(min)	10
Duress Code	●●●●●●
Super Password	●●●●●●
Unlock Password	●●●●●●

Figure 8-13 Door Parameters Settings Page

Tap **Save** to save the settings after the configuration.

Door No.

Select the device corresponded door No.

Name

You can create a name for the door.

Open Duration

Set the door unlocking duration. If the door is not opened for the set time, the door will be locked.

Door Open Timeout Alarm

An alarm will be triggered if the door has not been closed within the configured time duration.

Door Contact

You can set the door contact as **Remain Open** or **Remain Closed** according to your actual needs. By default, it is **Remain Closed**.

Exit Button Type

You can set the exit button as **Remain Open** or **Remain Closed** according to your actual needs. By default, it is **Remain Open**.

Extended Open Duration

The door contact can be enabled with appropriate delay after person with extended access needs swipes her/his card.

Door Remain Open Duration with First Person

Set the door open duration when first person is in. After the first person is authorized, it allows multiple persons access the door or other authentication actions.

Duress Code

The door can open by inputting the duress code when there is duress. At the same time, the client can report the duress event.

Super Password

The specific person can open the door by inputting the super password.

Unlock Password

The specific person can open the door by inputting the unlock password.



Note

The duress code and the super code should be different. And the digit ranges from 4 to 8.

Set RS-485 Parameters

You can set the RS-485 parameters including the peripheral, address, baud rate, etc.

Tap **Configuration** → **Access Control** → **RS-485** .

RS-485 Settings	<input checked="" type="checkbox"/>
RS-485 Protocol	Private >
No.	1 >
Peripheral Type	Card Reader >
RS-485 Address	1
Baud Rate	19200 >
Data Bit	8 >
Stop Bit	1 >
Parity	None >
Flow Ctrl	None >
Communication Mode	Half-Duplex >

Figure 8-14 RS-485 Page

Tap **Save** to save the settings after the configuration.

Peripheral Type

Select a peripheral from the drop-down list according the actual situation. You can select from **Card Reader**, **Extension Module**, or **Access Controller**.

Note

After the peripheral is changed and saved, the device will reboot automatically.

RS-485 Address

Set the RS-485 Address according to your actual needs.

Note

If you select **Access Controller**: If connect the device to a terminal via the RS-485 interface, set the RS-485 address as 2. If you connect the device to a controller, set the RS-485 address according to the door No.

Baud Rate

The baud rate when the devices are communicating via the RS-485 protocol.

Data Bit

The data bit when the devices are communicating via the RS-485 protocol.

Stop Bit

The stop bit when the devices are communicating via the RS-485 protocol.

Parity/Flow Ctrl/Communication Mode

Enabled by default.

Set Wiegand Parameters

You can set the Wiegand transmission direction.

Steps

1. Tap **Configuration** → **Access Control** → **Wiegand Settings** .

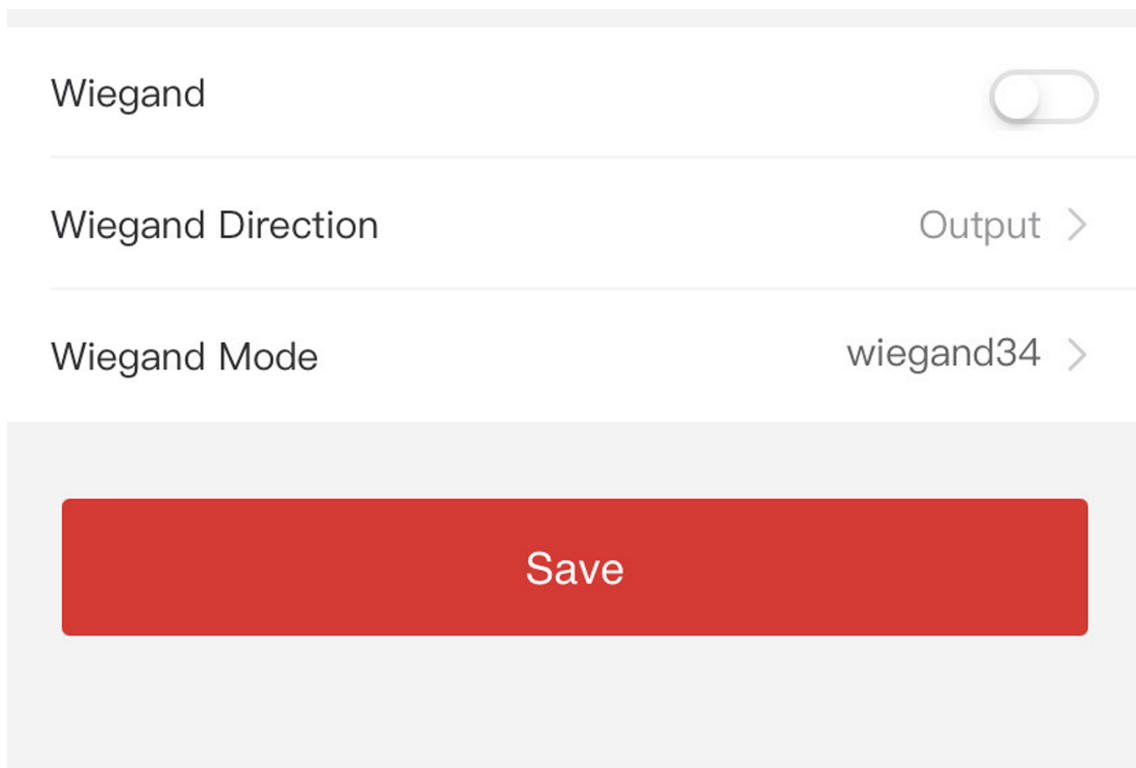

Figure 8-15 Wiegand Page

2. Enable **Wiegand** to enable the Wiegand function.
3. Set a transmission direction.

Output

The can connect an external access controller. And the two devices will transmit the card No. via Wiegand 26 or 34.

4. Tap **Save** to save the settings.



Note

If you change the peripheral, and after you save the device parameters, the device will reboot automatically.

8.5 Door Operation

You can operate the door remotely via mobile web.

Tap **Door Operation** to enter the operation page.

Tap  to open the door.

Tap  to close the door.

Tap  to set the door to remain open.

Tap  to set the door to remain closed.

Chapter 9 Client Software Configuration

You can call the hotline to get the Guarding Vision client software installation package.

9.1 Configuration Flow of Client Software

Follow the flow diagram below to configure on the client software.

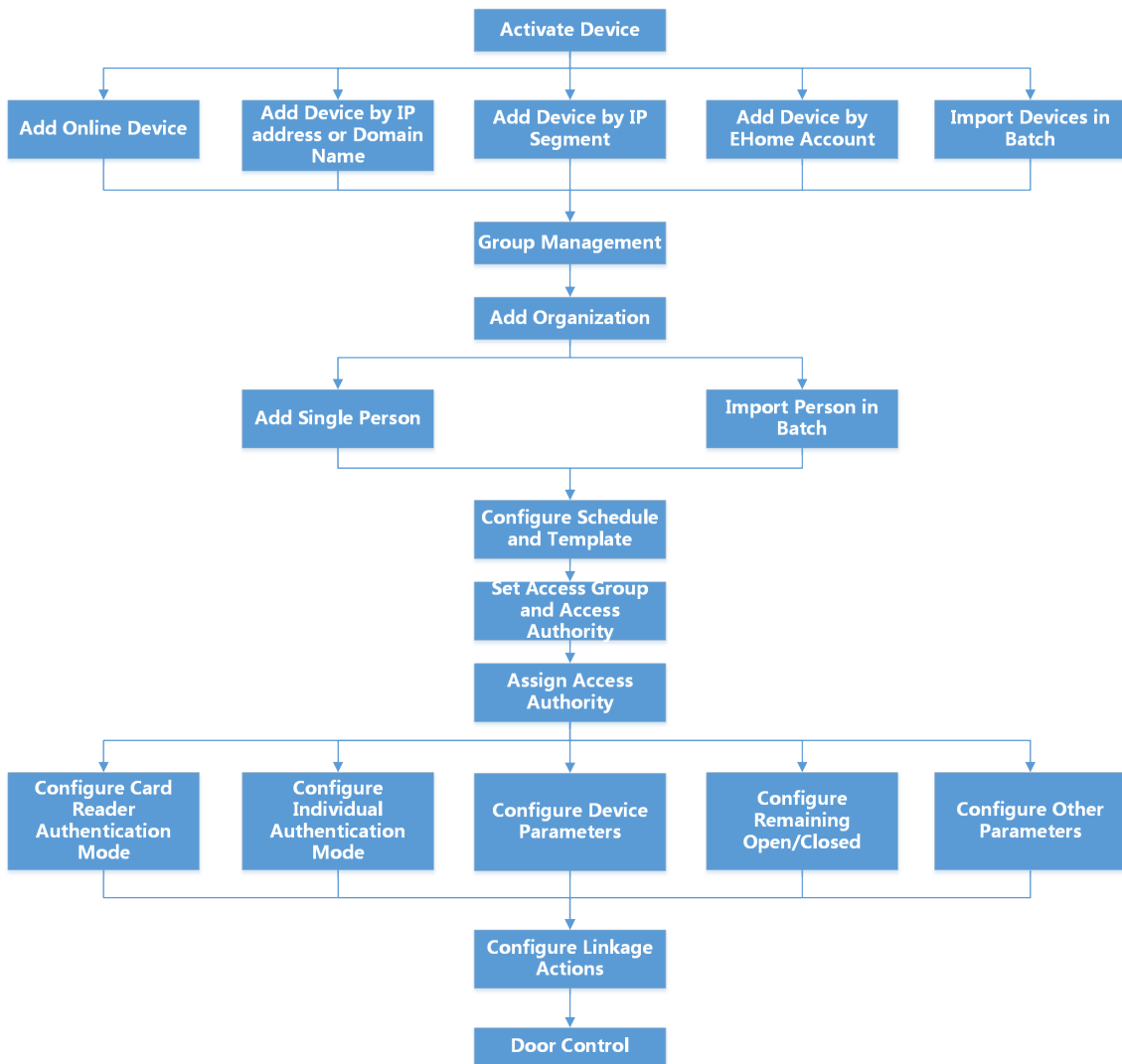

Figure 9-1 Flow Diagram of Configuration on Client Software

9.2 Device Management

The client supports managing access control devices and video intercom devices.

Example

You can control entrance & exit and manage attendance after adding access control devices to the client; you can perform video intercom with the indoor stations and door stations.

9.2.1 Add Device

The client provides three device adding modes including by IP/domain, IP segment, and ISUP protocol. The client also supports importing multiple devices in a batch when there are large amount of devices to be added.

Add Device by IP Address or Domain Name

If you know the IP address or domain name of the device to add, you can add devices to the client by specifying the IP address (or domain name), user name, password, etc.

Steps

1. Enter Device Management module.
2. Click **Device** tab on the top of the right panel.
The added devices are displayed on the right panel.

Add ✕

Adding Mode: IP/Domain IP Segment Cloud P2P
 EHome HiDDNS Batch Import

Add Offline Device

* Name

* Address

* Transmission Encrypti...

* Port

* User Name

* Password

Synchronize Time

Import to Group

ⓘ Set the device name as the group name and add all the channels connected to the device to the group.

Add and New **Add** Cancel

Figure 9-2 Add Device by IP Address or Domain Name

3. Click **Add** to open the Add window, and then select **IP/Domain** as the adding mode.
4. Enter the required information.

Name

Create a descriptive name for the device. For example, you can use a nickname that can show the location or feature of the device.

Address

The IP address or domain name of the device.

Port

The devices to add share the same port number. The default value is **80**.

User Name

Enter the device user name. By default, the user name is **admin**.

Password

Enter the device password.



Caution

The password strength of the device can be automatically checked. We highly recommend you change the password of your own choosing (using a minimum of 8 characters, including at least three kinds of following categories: upper case letters, lower case letters, numbers, and special characters) in order to increase the security of your product. And we recommend you change your password regularly, especially in the high security system, changing the password monthly or weekly can better protect your product.

Proper configuration of all passwords and other security settings is the responsibility of the installer and/or end-user.

- 5. Optional: Check Transmission Encryption (TLS)** to enable transmission encryption using TLS (Transport Layer Security) protocol for security purpose.
-



Note

- This function should be supported by the device.
 - If you have enabled Certificate Verification, you should click **Open Certificate Directory** to open the default folder, and copy the certificate file exported from the device to this default directory to strengthen the security. See for details about enabling certificate verification.
 - You can log into the device to get the certificate file by web browser.
-
- 6. Check Synchronize Time** to synchronize the device time with the PC running the client after adding the device to the client.
 - 7. Optional: Check Import to Group** to create a group by the device name, and import all the channels of the device to this group.

Example

For access control device, its access points, alarm inputs/outputs, and encoding channels (if exist) will be imported to this group.

- 8. Finish adding the device.**
 - Click **Add** to add the device and back to the device list page.
 - Click **Add and New** to save the settings and continue to add other device.

Import Devices in a Batch

You can add multiple devices to the client in a batch by entering the device parameters in a pre-defined CSV file.

Steps

- 1.** Enter the Device Management module.

2. Click **Device** tab on the top of the right panel.
3. Click **Add** to open the Add window, and then select **Batch Import** as the adding mode.

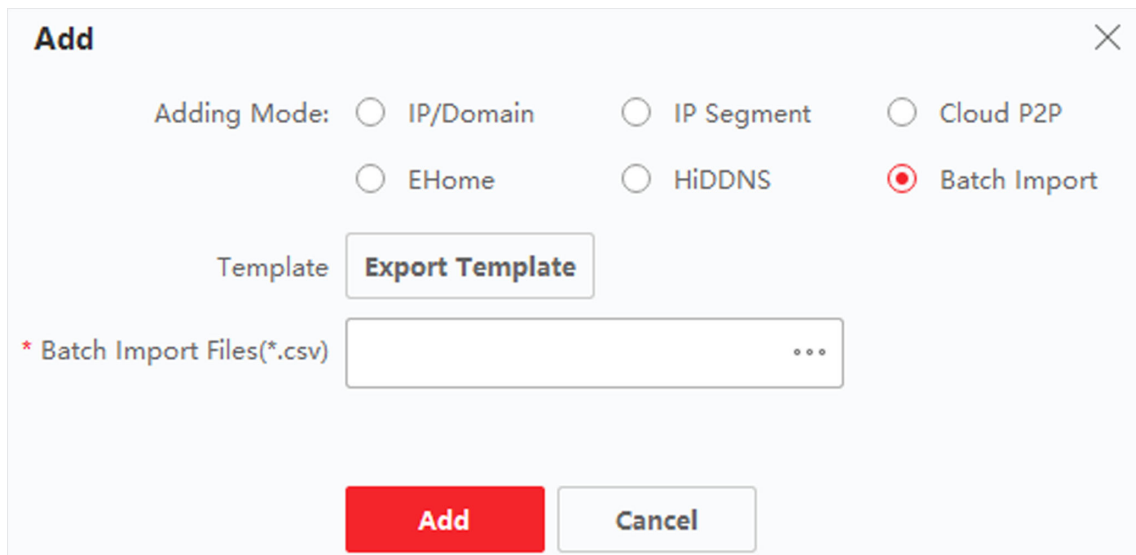

Figure 9-3 Add Devices in a Batch

4. Click **Export Template** and then save the pre-defined template (CSV file) on your PC.
5. Open the exported template file and enter the required information of the devices to be added on the corresponding column.

 **Note**

For detailed description of the required fields, refer to the introductions in the template.

Adding Mode

Enter **0** or **1** or **2**.

Address

Edit the address of the device.

Port

Enter the device port number. The default port number is **80**.

User Name

Enter the device user name. By default, the user name is **admin**.

Password

Enter the device password.

 **Caution**

The password strength of the device can be automatically checked. We highly recommend you change the password of your own choosing (using a minimum of 8 characters, including

at least three kinds of following categories: upper case letters, lower case letters, numbers, and special characters) in order to increase the security of your product. And we recommend you change your password regularly, especially in the high security system, changing the password monthly or weekly can better protect your product.

Proper configuration of all passwords and other security settings is the responsibility of the installer and/or end-user.

Import to Group

Enter **1** to create a group by the device name. All the channels of the device will be imported to the corresponding group by default. Enter **0** to disable this function.

6. Click  and select the template file.
7. Click **Add** to import the devices.

9.2.2 Reset Device Password

If you forgot the password of the detected online devices, you can reset the device password via the client.

Steps

1. Enter Device Management page.
2. Click **Online Device** to show the online device area.
All the online devices sharing the same subnet will be displayed in the list.
3. Select the device from the list and click  on the Operation column.
4. Reset the device password.
 - Click **Generate** to pop up the QR Code window and click **Download** to save the QR code to your PC. You can also take a photo of the QR code to save it to your phone. Send the picture to our technical support.

Note

For the following operations for resetting the password, contact our technical support.

Caution







The password strength of the device can be automatically checked. We highly recommend you change the password of your own choosing (using a minimum of 8 characters, including at least three kinds of following categories: upper case letters, lower case letters, numbers, and special characters) in order to increase the security of your product. And we recommend you change your password regularly, especially in the high security system, changing the password monthly or weekly can better protect your product.

Proper configuration of all passwords and other security settings is the responsibility of the installer and/or end-user.

9.2.3 Manage Added Devices

After adding devices to device list, you can manage the added devices including editing device parameters, remote configuration, viewing device status, etc.

Table 9-1 Manage Added Devices

Edit Device	Click  to edit device information including device name, address, user name, password, etc.
Delete Device	Check one or more devices, and click Delete to delete the selected devices.
Remote Configuration	Click  to set remote configuration of the corresponding device. For details, refer to the user manual of device.
View Device Status	Click  to view device status, including door No., door status, etc.  Note For different devices, you will view different information about device status.
View Online User	Click  to view the details of online user who access the device, including user name, user type, IP address and login time.
Refresh Device Information	Click  to refresh and get the latest device information.

9.3 Group Management

The client provides groups to manage the added resources in different groups. You can group the resources into different groups according to the resources' locations.

Example

For example, on the 1st floor, there mounted 16 doors, 64 alarm inputs, and 16 alarm outputs. You can organize these resources into one group (named 1st Floor) for convenient management. You can control door status, and do some other operations of the devices after managing the resources by groups.

9.3.1 Add Group

You can add group to organize the added device for convenient management.

Steps

1. Enter the Device Management module.

2. Click **Device Management** → **Group** to enter the group management page.
3. Create a group.
 - Click **Add Group** and enter a group name as you want.
 - Click **Create Group by Device Name** and select an added device to create a new group by the name of the selected device.

Note

The resources (such as alarm inputs/outputs, access points, etc.) of this device will be imported to the group by default.

9.3.2 Import Resources to Group

You can import the device resources (such as alarm inputs/outputs, access points, etc.) to the added group in a batch.



Before You Start

Add a group for managing devices. Refer to [Add Group](#) .

Steps

1. Enter the Device Management module.
2. Click **Device Management** → **Group** to enter the group management page.
3. Select a group from the group list and select the resource type as **Access Point**, **Alarm Input**, **Alarm Output**, etc.
4. Click **Import**.
5. Select the thumbnails/names of the resources in the thumbnail/list view.

Note

You can click  or  to switch the resource display mode to thumbnail view or to list view.

6. Click **Import** to import the selected resources to the group.

9.4 Person Management

You can add person information to the system for further operations such as access control, video intercom, time and attendance, etc. You can manage the added persons such as issuing cards to them in a batch, importing and exporting person information in a batch, etc.

9.4.1 Add Organization

You can add an organization and import person information to the organization for effective management of the persons. You can also add a subordinate organization for the added one.

Steps

1. Enter **Person** module.

2. Select a parent organization in the left column and click **Add** in the upper-left corner to add an organization.
3. Create a name for the added organization.

Note

Up to 10 levels of organizations can be added.

4. **Optional:** Perform the following operation(s).

Edit Organization Hover the mouse on an added organization and click  to edit its name.

Delete Organization Hover the mouse on an added organization and click  to delete it.

Note

- The lower-level organizations will be deleted as well if you delete an organization.
 - Make sure there is no person added under the organization, or the organization cannot be deleted.
-

Show Persons in Sub Organization Check **Show Persons in Sub Organization** and select an organization to show persons in its sub organizations.

9.4.2 Configure Basic Information

You can add person to the client one by one and configure the person's basic information such as name, gender, email, phone number, etc.

Steps

1. Enter **Person** module.
-

Note

For the first time you enter **Person** module, a window pops up, and you can set the rules to generate person ID (letters and numbers supported) when adding person. When getting person information from device, if there are no person IDs, the person IDs will be generated according to the rule.

2. Select an organization in the organization list to add the person.
3. Click **Add** to open the adding person window.
The Person ID will be generated automatically.
4. Enter the basic information including person name, gender, telephone number, email address, validity period, etc.

Basic Information

* Person ID

* Name

Gender Male Female

Email

Tel.

Validity Period (Access Control)

Remark

Figure 9-4 Configure Basic Information

Note

Once validity period expired, the credentials and access control settings of the person will be invalid and the person will have no authorization to access the doors\floors. You can click **Extend** to extend the person's validity period for 1 month, 3 months, 6 months, or 1 year.

5. Confirm to add the person.
 - Click **Add** to add the person and close the Add Person window.
 - Click **Add and New** to add the person and continue to add other persons.
6. Delete Registered Face Picture

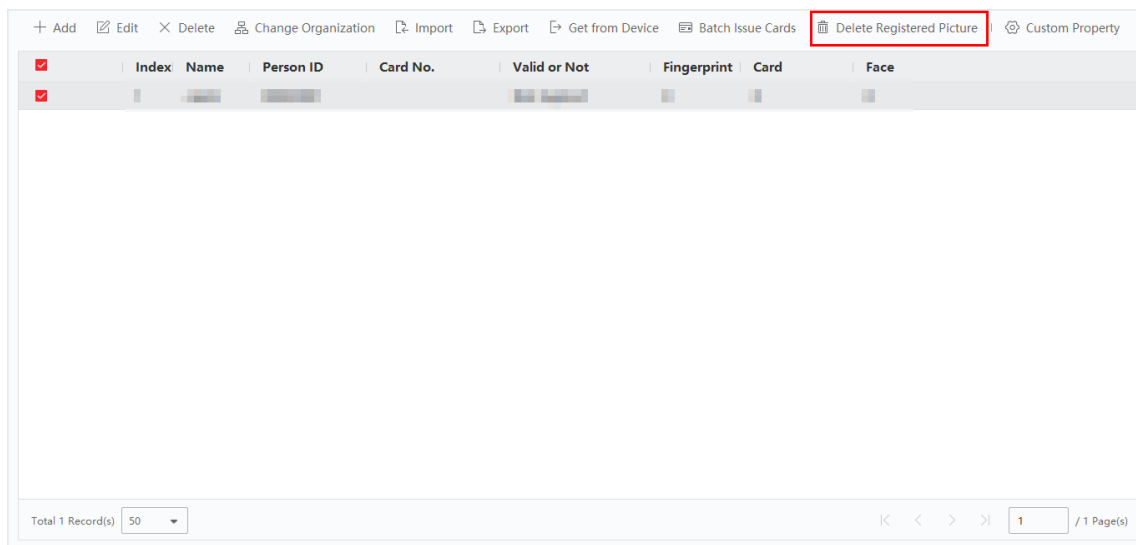

Figure 9-5 Delete Registered Picture

Note

If **Save Pictures in Structure Data Format** is enabled, the **Delete Registered Picture** button will be added to the **Person** page. In general, the registered face picture will be deleted automatically once the person's information is applied to the device. By double clicking the person, the **Edit Person** window will pop up, and you can check whether the registered face picture has been deleted. If not, you can select this person and click **Delete Registered Picture** to delete the picture manually.

9.4.3 Issue a Card by Local Mode

If a card enrollment station is available, you can issue a card by local mode. To read the card number, you should connect the card enrollment station to the PC running the client by USB interface or COM, and place the card on the card enrollment station.

Steps

1. Enter **Person** module.
2. Select an organization in the organization list to add the person and click **Add** to enter Add Person panel.

Note

Enter the person's basic information first. For details about configuring person's basic information, refer to ***Configure Basic Information*** .

3. In the **Credential** → **Card** area, click  .
4. Click **Settings** to enter the Settings page.
5. Select **Local** as the card issuing mode.

6. Set other related parameters.

Card Enrollment Station

Select a model of card enrollment station from the drop-down list. You can connect the card enrollment station to the PC, and transfer the basic information about the added person between the two devices through USB.

Note

The currently supported models of card enrollment station: DS-K1F100-D8, DS-K1F100-M, DS-K1F100-D8E, DS-K1F180-D8E, DS-K1F100A-D8E, and enrollment station.

Card Type

This field is only available when the model is DS-K1F100-D8E or DS-K1F180-D8E. Select the card type as EM card or Mifare card according to the actual card type.

Buzzing

Enable or disable the buzzing when the card number is read successfully.

Card No. Type

Select the type of the card number according to actual needs.

M1 Card Encryption

This field is only available when the model is DS-K1F100-D8, DS-K1F100-D8E, or DS-K1F180-D8E. If the card is M1 card, then you can enable the M1 Card Encryption function and select the sector of the card to encrypt.

7. Click **OK** to confirm the operation.
8. Place the card on the card enrollment station, and click **Read** to get the card number.
The card number will display in the Card No. field automatically.
9. Click **Add**.
The card will be issued to the person.

9.4.4 Collect Fingerprint via Client

Collecting fingerprints locally means you can collect the fingerprint via the fingerprint recorder connected directly to the PC running the client. The fingerprints recorded can be used as credentials of the persons to access the authorized doors.

Before You Start

Connect the fingerprint recorder to the PC running the client.

Steps

1. Enter **Person** module.
2. Select an organization in the organization list to add the person and click **Add**.

Note

Enter the person's basic information first. For details about configuring person's basic information, refer to [Configure Basic Information](#) .

3. In the **Credential** → **Fingerprint** panel, click  .
 4. In the pop-up window, select the collection mode as **Local**.
 5. Select the model of the connected fingerprint recorder.
-

Note

If the fingerprint recorder is DS-K1F800-F, you can click **Settings** to select the COM the fingerprint recorder connects to.

6. Collect the fingerprint.
 - 1) Click **Start**.
 - 2) Place and lift your fingerprint on the fingerprint recorder to collect the fingerprint.
 - 3) Click **Add** to save the recorded fingerprint.
 7. Confirm to add the person.
 - Click **Add** to add the person and close the Add Person window.
 - Click **Add and New** to add the person and continue to add other persons.
-

Note

Once the fingerprint is added, the fingerprint type cannot be changed.

9.4.5 Collect Fingerprint via Access Control Device

When adding person, you can collect fingerprint information via the access control device's fingerprint module. The fingerprints recorded can be used as credentials of the persons to access the authorized doors.

Before You Start

Make sure fingerprint collection is supported by the access control device.

Steps

1. Enter **Person** module.
 2. Select an organization in the organization list to add the person and click **Add**.
-

Note

Enter the person's basic information first. For details about configuring person's basic information, refer to [Configure Basic Information](#) .

3. In the **Credential** → **Fingerprint** panel, click  .
 4. In the pop-up window, select the collection mode as **Remote**.
 5. Select an access control device which supports fingerprint recognition function from the drop-down list.
 6. Collect the fingerprint.
-

- 1) Click **Start**.
 - 2) Place and lift your fingerprint on the fingerprint scanner of the selected access control device to collect the fingerprint.
 - 3) Click **Add** to save the recorded fingerprint.
7. Confirm to add the person.
- Click **Add** to add the person and close the Add Person window.
 - Click **Add and New** to add the person and continue to add other persons .
-

Note

Once the fingerprint is added, the fingerprint type cannot be changed.

9.4.6 Configure Access Control Information

When adding a person, you can set her/his access control information, such as binding an access control group with the person, configuring PIN code, setting the person as a visitor, a blocklist person, or a super user, etc.

Steps

1. Enter **Person** module.
 2. Select an organization in the organization list to add the person and click **Add**.
 3. In the **Access Control** area, click  to select access group(s) for the person.
-

Note

For details, refer to ***Set Access Group to Assign Access Authorization to Persons*** .

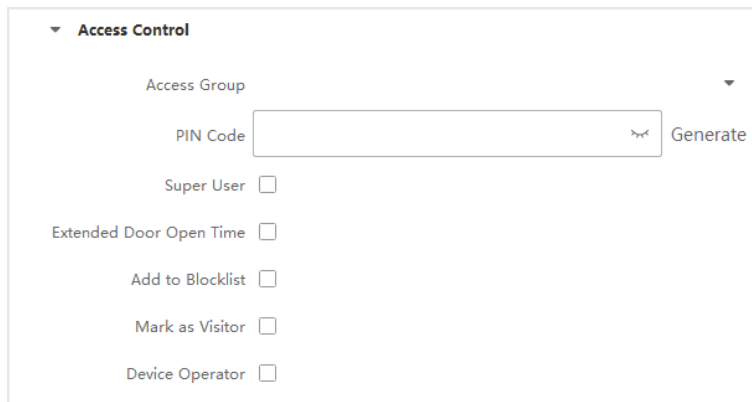

The screenshot shows a configuration window titled "Access Control". It contains the following elements:

- A dropdown menu labeled "Access Group" with a downward arrow.
- A text input field labeled "PIN Code" with a "Generate" button to its right.
- A checkbox labeled "Super User".
- A checkbox labeled "Extended Door Open Time".
- A checkbox labeled "Add to Blocklist".
- A checkbox labeled "Mark as Visitor".
- A checkbox labeled "Device Operator".

Figure 9-6 Configure Access Control Information

4. Set a unique PIN code for the person which can be used for access authentication.
 - Manually enter a PIN code containing 4 to 8 digits.
-

Note

Persons' PIN codes cannot be repeated.

- Click **Generate** to randomly generate an unrepeated PIN code of 6 digits.

Note

If there are repeated PIN codes, a prompt will pop up on the client. The admin can generate a new PIN code to replace the repeated PIN code and notify related persons.

5. Check the person's operation permissions.

Super User

If the person is set as a super user, he/she will have authorization to access all the doors/floors and will be exempted from remaining closed restrictions, all anti-passback rules, and first person authorization.

Extended Door Open Time

Use this function for persons with reduced mobility. When accessing the door, the person will have more time than others to pass through doors.

For details about setting the door's open duration, refer to [***Configure Parameters for Door***](#) .

Add to Blocklist

Add the person to the blocklist and when the person tries to access doors/floors, an event will be triggered and sent to the client to notify the security personnel.

Mark as Visitor

If the person is a visitor, you should set the her/his valid times for visit.

Note

The valid times for visit is between 1 and 100. You can also check **No Limit**, then there are no limited times for the visitor to access doors/floors.

Device Operator

For person with device operator role, he/she is authorized to operate on the access control devices.

Note

The Super User, Extended Door Open Time, Add to Blocklist, and Mark as Visitor functions cannot be enabled concurrently. For example, if one person is set as super user, you cannot enable extended door open time for her/him, add her/him to the blocklist, or set her/him as visitor.

6. Confirm to add the person.

- Click **Add** to add the person and close the Add Person window.
- Click **Add and New** to add the person and continue to add other persons.

9.4.7 Customize Person Information

You can customize the person properties which are not pre-defined in the client according to actual needs, e.g., place of birth. After customizing, when add a person, you can enter the custom information to make the person information complete.

Steps

1. Enter **Person** module.
2. Set the fields of custom information.
 - 1) Click **Custom Property**.
 - 2) Click **Add** to add a new property.
 - 3) Enter the property name.
 - 4) Click **OK**.
3. Set the custom information when adding a person.
 - 1) Select an organization in the organization list to add the person and click **Add**.



Enter the person's basic information first. For details about configuring person's basic information, refer to [Configure Basic Information](#) .

- 2) In the **Custom Information** panel, enter the person information.
- 3) Click **Add** to add the person and close the Add Person window, or click **Add and New** to add the person and continue to add other persons.

9.4.8 Configure Additional Information

When adding person, you can configure the additional information for the person, such as person's identity type, identity No., country, etc., according to actual needs.

Steps

1. Enter **Person** module.
2. Select an organization in the organization list to add the person and click **Add**.



Enter the person's basic information first. For details about configuring person's basic information, refer to [Configure Basic Information](#) .

3. In the **Additional Information** panel, enter the additional information of the person, including person's ID type, ID No., job title, etc., according to actual needs.
4. Confirm to add the person.
 - Click **Add** to add the person and close the Add Person window.
 - Click **Add and New** to add the person and continue to add other persons .

9.4.9 Import and Export Person Identify Information

You can import the information of multiple persons to the client software in a batch. Meanwhile, you can also export the person information and save them in your PC.

9.4.10 Import Person Information

You can enter the information of multiple persons in a predefined template (CSV/Excel file) to import the information to the client in a batch.

Steps

1. Enter the Person module.
2. Select an added organization in the list, or click **Add** in the upper-left corner to add an organization and then select it.
3. Click **Import** to open the Import panel.
4. Select **Person Information** as the importing mode.
5. Click **Download Template for Importing Person** to download the template.
6. Enter the person information in the downloaded template.

Note

- If the person has multiple cards, separate the card No. with semicolon.
- Items with asterisk are required.
- By default, the Hire Date is the current date.

-
7. Click **...** to select the CSV/Excel file with person information from local PC.
 8. Click **Import** to start importing.

Note

- If a person No. already exists in the client's database, delete the existing information before importing.
 - You can import information of no more than 2,000 persons.
-

9.4.11 Export Person Information

You can export the added persons' information to local PC as a CSV/Excel file.

Before You Start

Make sure you have added persons to an organization.

Steps

1. Enter the Person module.
2. **Optional:** Select an organization in the list.

Note

All persons' information will be exported if you do not select any organization.

3. Click **Export** to open the Export panel.
4. Check **Person Information** as the content to export.
5. Check desired items to export.
6. Click **Export** to save the exported file in CSV/Excel file on your PC.

9.4.12 Get Person Information from Access Control Device

If the access control device has been configured with person information (including person details, fingerprint, and issued card information), you can get the person information from the added device and import them to the client for further operations.

Steps

Note

- If the person name stored in the device is empty, the person name will be filled with the issued card No. after importing to the client.
 - The gender of the persons will be **Male** by default.
 - If the card number or person ID (employee ID) stored on the device already exists in the client database, the person with this card number or person ID will not be imported to the client.
-

1. Enter **Person** module.
 2. Select an organization to import the persons.
 3. Click **Get from Device**.
 4. Select an added access control device or the enrollment station from the drop-down list.
-

Note

If you select the enrollment station, you should click **Login**, and enter IP address, port No., user name and password of the device.

5. Select the **Getting Mode**.
-

Note

The getting mode varies according to different devices. The access control device supports getting the person information by employee ID. Up to 5 employee IDs can be specified each time.

6. Click **Import** to start importing the person information to the client.
-

Note

Up to 2,000 persons and 5,000 cards can be imported.

The person information, including person details, person's fingerprint information (if configured), and the linked cards (if configured), will be imported to the selected organization.

9.4.13 Move Persons to Another Organization

You can move the added persons to another organization if you need.

Before You Start

- Make sure you have added at least two organizations.
- Make sure you have imported person information.

Steps

1. Enter **Person** module.
2. Select an organization in the left panel.
The persons under the organization will be displayed in the right panel.
3. Select the person to move.
4. Click **Change Organization**.
5. Select the organization to move persons to.
6. Click **OK**.

9.4.14 Issue Cards to Persons in Batch

The client provides a convenient way to issue cards to multiple persons in a batch.



Steps

1. Enter **Person** module.
2. Click **Batch Issue Cards**.
All the added persons with no card issued will be displayed in the right panel.
3. **Optional:** Enter key words (name or person ID) in the input box to filter the person(s) that need issuing cards.
4. **Optional:** Click **Settings** to set the card issuing parameters. For details, refer to *Issue a Card by Local Mode*.
5. Click **Initialize** to initialize the card enrollment station or card reader to make it ready for issuing cards.
6. Click the **Card No.** column and enter the card number.
 - Place the card on the card enrollment station.
 - Swipe the card on the card reader.
 - Manually enter the card number and press the **Enter** key.The person(s) in the list will be issued with card(s).

9.4.15 Report Card Loss

If the person lost his/her card, you can report the card loss so that the card's related access authorization will be inactive.

Steps

1. Enter **Person** module.
2. Select the person you want to report card loss for and click **Edit** to open the Edit Person window.
3. In the **Credential** → **Card** panel, click  on the added card to set this card as lost card.
After reporting card loss, the access authorization of this card will be invalid and inactive. Other person who gets this card cannot access the doors by swiping this lost card.
4. **Optional:** If the lost card is found, you can click  to cancel the loss.
After cancelling card loss, the access authorization of the person will be valid and active.
5. If the lost card is added in one access group and the access group is applied to the device already, after reporting card loss or cancelling card loss, a window will pop up to notify you to apply the changes to the device. After applying to device, these changes can take effect on the device.

9.4.16 Set Card Issuing Parameters

The client provides two modes for reading a card's number: via card enrollment station or via the card reader of the access control device. If a card enrollment station is available, connect it to the PC running the client by USB interface or COM, and place the card on the card enrollment to read the card number. If not, you can also swipe the card on the card reader of the added access control device to get the card number. As a result, before issuing a card to one person, you need to set the card issuing parameters including the issuing mode and related parameters.

When adding a card to one person, click **Settings** to open the Card Issuing Settings window.

Local Mode: Issue Card by Card Enrollment Station

Connect a card enrollment station to the PC running the client. You can place the card on the card enrollment station to get the card number.

Card Enrollment Station

Select the model of the connected card enrollment station



Note

Currently, the supported card enrollment station model is DS-K1F180-D8E.

Card Type

Select the card type as EM card or IC card according to the actual card type.

Buzzing

Enable or disable the buzzing when the card number is read successfully.

Card No. Type

Select the type of the card number according to actual needs.

M1 Card Encryption

If the card is M1 card, and if you need to enable the M1 Card Encryption function, you should enable this function and select the sector of the card to encrypt.

Remote Mode: Issue Card by Card Reader

Select an access control device added in the client and swipe the card on its card reader to read the card number.

9.5 Configure Schedule and Template

You can configure the template including holiday and week schedule. After setting the template, you can adopt the configured template to access groups when setting the access groups, so that the access group will take effect in the time durations of the template.

Note

For access group settings, refer to [*Set Access Group to Assign Access Authorization to Persons*](#) .

9.5.1 Add Holiday

You can create holidays and set the days in the holidays, including start date, end date, and holiday duration in one day.

Steps

Note

You can add up to 64 holidays in the software system.

1. Click **Access Control** → **Schedule** → **Holiday** to enter the Holiday page.
 2. Click **Add** on the left panel.
 3. Create a name for the holiday.
 4. **Optional:** Enter the descriptions or some notifications of this holiday in the Remark box.
 5. Add a holiday period to the holiday list and configure the holiday duration.
-

Note





Up to 16 holiday periods can be added to one holiday.

- 1) Click **Add** in the Holiday List field.
 - 2) Drag the cursor to draw the time duration, which means in that duration of time, the configured access group is activated.
-

Note

Up to 8 time durations can be set to one holiday period.

- 3) **Optional:** Perform the following operations to edit the time durations.
-

- Move the cursor to the time duration and drag the time duration on the timeline bar to the desired position when the cursor turns to .
 - Click the time duration and directly edit the start/end time in the appeared dialog.
 - Move the cursor to the start or the end of time duration and drag to lengthen or shorten the time duration when the cursor turns to .
- 4) **Optional:** Select the time duration(s) that need to be deleted, and then click  in the Operation column to delete the selected time duration(s).
 - 5) **Optional:** Click  in the Operation column to clear all the time duration(s) in the time bar.
 - 6) **Optional:** Click  in the Operation column to delete this added holiday period from the holiday list.
6. Click **Save**.

9.5.2 Add Template

Template includes week schedule and holiday. You can set week schedule and assign the time duration of access authorization for different person or group. You can also select the added holiday(s) for the template.

Steps

Note

You can add up to 255 templates in the software system.

1. Click **Access Control** → **Schedule** → **Template** to enter the Template page.
-

Note

There are two default templates: All-Day Authorized and All-Day Denied, and they cannot be edited or deleted.

All-Day Authorized

The access authorization is valid in each day of the week and it has no holiday.

All-Day Denied



The access authorization is invalid in each day of the week and it has no holiday.

2. Click **Add** on the left panel to create a new template.
 3. Create a name for the template.
 4. Enter the descriptions or some notification of this template in the Remark box.
 5. Edit the week schedule to apply it to the template.
 - 1) Click **Week Schedule** tab on the lower panel.
 - 2) Select a day of the week and draw time duration(s) on the timeline bar.
-

Note

Up to 8 time duration(s) can be set for each day in the week schedule.

- 3) **Optional:** Perform the following operations to edit the time durations.
-

- Move the cursor to the time duration and drag the time duration on the timeline bar to the desired position when the cursor turns to .
 - Click the time duration and directly edit the start/end time in the appeared dialog.
 - Move the cursor to the start or the end of time duration and drag to lengthen or shorten the time duration when the cursor turns to .
- 4) Repeat the two steps above to draw more time durations on the other days of the week.
6. Add a holiday to apply it to the template.
-

Note

Up to 4 holidays can be added to one template.

- 1) Click **Holiday** tab.
 - 2) Select a holiday in the left list and it will be added to the selected list on the right panel.
 - 3) **Optional:** Click **Add** to add a new holiday.
-

Note

For details about adding a holiday, refer to ***Add Holiday***.

- 4) **Optional:** Select a selected holiday in the right list and click  to remove the selected one, or click **Clear** to clear all the selected holiday(s) in the right list.
7. Click **Save** to save the settings and finish adding the template.
-

9.6 Set Access Group to Assign Access Authorization to Persons

After adding the person and configuring the person's credentials, you can create the access groups to define which person(s) can get access to which door(s) and then apply the access group to the access control device to take effect.

Before You Start

- Add person to the client.
- Add access control device to the client and group access points. For details, refer to ***Group Management***.
- Add template.

Steps

When the access group settings are changed, you need to apply the access groups to the devices again to take effect. The access group changes include changes of template, access group settings, person's access group settings, and related person details (including card number, fingerprint, face picture, linkage between card number and fingerprint, linkage between card number and fingerprint, card password, card effective period, etc).

1. Click **Access Control** → **Authorization** → **Access Group** to enter the Access Group interface.
 2. Click **Add** to open the Add window.
 3. In the **Name** text field, create a name for the access group as you want.
 4. Select a template for the access group.
-

 **Note**

You should configure the template before access group settings. Refer to **Configure Schedule and Template** for details.

5. In the left list of the Select Person field, select person(s) to assign access authority.
6. In the left list of the Select Access Point field, select door(s), door station(s) or floor(s) for the selected persons to access.
7. Click **Save**.

You can view the selected person(s) and the selected access point(s) on the right side of the interface.

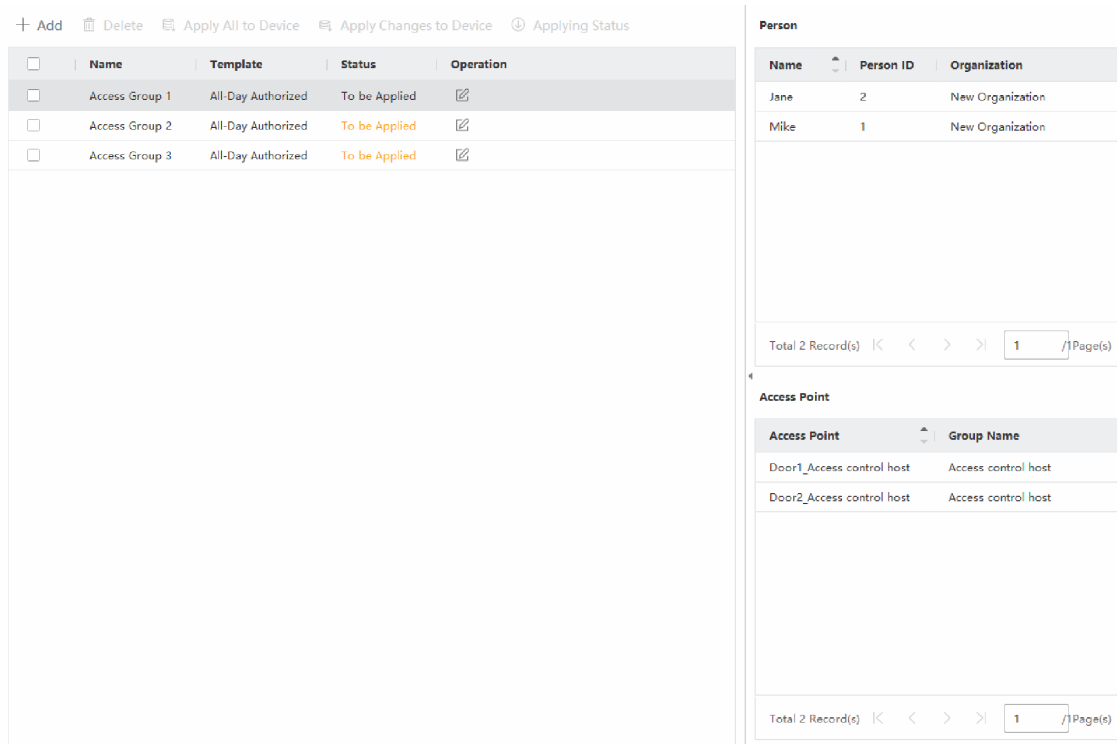

Figure 9-7 Display the Selected Person(s) and Access Point(s)

8. After adding the access groups, you need to apply them to the access control device to take effect.
 - 1) Select the access group(s) to apply to the access control device.
 - 2) Click **Apply All to Devices** start applying all the selected access group(s) to the access control device or door station.
 - 3) Click **Apply All to Devices** or **Apply Changes to Devices**.

Apply All to Devices

This operation will clear all the existed access groups of the selected devices and then apply the new access group to the device.

Apply Changes to Devices

This operation will not clear the existed access groups of the selected devices and only apply the changed part of the selected access group(s) to the device(s).

- 4) View the applying status in the Status column or click **Applying Status** to view all the applied access group(s).

Note

You can check **Display Failure Only** to filter the applying results.

The selected persons in the applied access groups will have the authorization to enter/exit the selected doors/door stations with their linked card(s) or fingerprints.

9. **Optional:** Click  to edit the access group if necessary.

Note

If you change the persons' access information or other related information, you will view the prompt **Access Group to Be Applied** on the right corner of the client.

You can click the prompt to apply the changed data to the device. You can select either **Apply Now** or **Apply Later**.

9.7 Configure Advanced Functions

You can configure the advanced functions of access control to meet some special requirements in different scene.

Note

- For the card related functions(the type of access control card), only the card(s) with access group applied will be listed when adding cards.
 - The advanced functions should be supported by the device.
 - Hover the cursor on the Advanced Function, and then Click  to customize the advanced function(s) to be displayed.
-

9.7.1 Configure Device Parameters

After adding the access control device, you can configure the parameters of access control device, access control points.

Configure Parameters for Access Control Device

After adding the access control device, you can configure its parameters, including overlaying user information on picture, uploading pictures after capturing, saving captured pictures, etc.

Before You Start

Add access control device to the client.

Steps

1. Click **Access Control** → **Advanced Function** → **Device Parameter** .
-



If you can not find Device Parameter in the Advanced Function list, hover the cursor on the Advanced Function, and then Click  to select the Device Parameter to be displayed.

2. Select an access device to show its parameters on the right page.
 3. Turn the switch to ON to enable the corresponding functions.
-



- The displayed parameters may vary for different access control devices.
 - Some of the following parameters are not listed in the Basic Information page, click **More** to edit the parameters.
-

RS-485 Comm. Redundancy

You should enable this function if you wire the RS-485 card reader to the access control device redundantly.

Display Detected Face

Display face picture when authenticating.

Display Card Number

Display the card information when authenticating.

Display Person Information

Display the person information when authenticating.

Overlay Person Info. on Picture

Display the person information on the captured picture.

Voice Prompt

If you enable this function, the voice prompt is enabled in the device. You can hear the voice prompt when operating in the device.

Upload Pic. After Linked Capture

Upload the pictures captured by linked camera to the system automatically.

Save Pic. After Linked Capture

If you enable this function, you can save the picture captured by linked camera to the device.

Press Key to Enter Card Number

If you enable this function, you can input the card No. by pressing the key.

Wi-Fi Probe

If you enable this function, the device can probe the surrounding communication devices' MAC address and upload the MAC address to the system. If the MAC address match the specified MAC address, the system can trigger some linkage actions.

3G/4G

If you enable this function, the device can communicate in 3G/4G network.

NFC Anti-Cloning

If you enable this function, you cannot use the cloned card for authentication and further enhance security.

4. Click **OK**.

5. **Optional:** Click **Copy to**, and then select the access control device(s) to copy the parameters in the page to the selected device(s).

Configure Parameters for Door

After adding the access control device, you can configure its access point parameters.

Steps

1. Click **Access Control** → **Advanced Function** → **Device Parameter** .
2. Select an access control device on the left panel, and then click  to show the doors of the selected device.
3. Select a door to show its parameters on the right page.
4. Edit the door or floor parameters.



Note

- The displayed parameters may vary for different access control devices.
 - Some of the following parameters are not listed in the Basic Information page, click **More** to edit the parameters.
-

Name

Edit the card reader name as desired.

Door Contact

You can set the door sensor as remaining closed or remaining open. Usually, it is remaining closed.

Exit Button Type

You can set the exit button as remaining closed or remaining open. Usually, it is remaining open.

Door Locked Time

After swiping the normal card and relay action, the timer for locking the door starts working.

Door Open Timeout Alarm

The alarm can be triggered if the door has not been closed in a configured time period. If it is set as 0, no alarm will be triggered.

Super Password

The specific person can open the door by inputting the super password.

Extended Open Duration

The door contact can be enabled with appropriate delay after person with extended access needs swipes her/his card.

Duress Code

The door can open by inputting the duress code when there is duress. At the same time, the client can report the duress event.

Dismiss Code

Create a dismiss code which can be used to stop the buzzer of the card reader (by entering the dismiss code on the keypad).



Note

- The duress code, super code, and dismiss code should be different.
- The duress code, super password, and the dismiss code should be different from the authentication password.
- The length of duress code, super password, and the dismiss code is according the device, usually it should contains 4 to 8 digits.

5. Click **OK**.

6. **Optional:** Click **Copy to** , and then select the door to copy the parameters in the page to the selected doors.



Note

The door's status duration settings will be copied to the selected door as well.

Configure Parameters for Card Reader

After adding the access control device, you can configure its card reader parameters.

Steps

1. Click **Access Control** → **Advanced Function** → **Device Parameter** .
2. In the device list on the left, click  to expand the door, select a card reader and you can edit the card reader's parameters on the right.
3. Edit the card reader basic parameters in the Basic Information page.



Note

- The displayed parameters may vary for different access control devices. There are part of parameters listed as follows. Refer to the user manual of the device for more details.
- Some of the following parameters are not listed in the Basic Information page, click **More** to edit the parameters.

Name

Edit the card reader name as desired.

Minimum Card Swiping Interval

If the interval between card swiping of the same card is less than the set value, the card swiping is invalid. You can set it as 0 to 255.

Alarm of Max. Failed Attempts

Enable to report alarm when the card reading attempts reach the set value.

Max. Times of Card Failure

Set the max. failure attempts of reading card.

Card Reader Type/Card Reader Description

Get card reader type and description. They are read-only.

Default Authentication Mode

View the default card reader authentication mode.

Fingerprint Capacity

View the maximum number of available fingerprints.

Existing Fingerprint Number

View the number of existed fingerprints in the device.

4. Click **Advanced** and you can configure more parameters.

Enable Card Reader

Enable the function and you can operate the functions below on the card reader.

OK LED Polarity/Error LED Polarity/Buzzer Polarity

Set OK LED Polarity/Error LED Polarity/Buzzer LED Polarity of main board according to the card reader parameters. Generally, adopts the default settings.

Max. Interval When Entering PWD

When you inputting the password on the card reader, if the interval between pressing two digits is larger than the set value, the digits you pressed before will be cleared automatically.

Tampering Detection

Enable the anti-tamper detection for the card reader.

Fingerprint Recognition Level

Select the fingerprint recognition level from the drop-down list.

Fingerprint Recognition Interval

Select the fingerprint recognition interval from the drop-down list.

5. Click **OK**.

6. **Optional:** Click **Copy to**, and then select the card reader(s) to copy the parameters in the page to the selected card reader(s).

Configure Parameters for Alarm Output

After adding the access control device, if the device links to alarm outputs, you can configure the parameters.

Before You Start

Add access control device to the client, and make sure the device supports alarm output.

Steps

1. Click **Access Control** → **Advanced Function** → **Device Parameter** to enter access control parameter configuration page.
2. In the device list on the left, click  to expand the door, select an alarm input and you can edit the alarm input's parameters on the right.
3. Set the alarm output parameters.

Name

Edit the card reader name as desired.

Alarm Output Active Time

How long the alarm output will last after triggered.

4. Click **OK**.
5. **Optional:** Set the switch on the upper right corner to **ON** to trigger the alarm output.

9.7.2 Configure Remaining Unlocked/Locked

You can set the status of the door as unlocked or locked and set the elevator controller as free and controlled. For example, you can set the door remaining locked in the holiday, and set the door remaining unlocked in the specified period of the work day.

Before You Start

Add the access control devices to the system.



Steps

1. Click **Access Control** → **Advanced Function** → **Remain Locked/Unlocked** to enter the Remain Locked/Unlocked page.
2. Select the door or elevator controller that need to be configured on the left panel.
3. To set the door or elevator controller status during the work day, click the **Week Schedule** and perform the following operations.
 - 1) For door, click **Remain Unlocked** or **Remain Locked**.
 - 2) For elevator controller, click **Free** or **Controlled**.
 - 3) Drag the cursor to draw the time duration, which means in that duration of time, the configured access group is activated.

Note

Up to 8 time durations can be set to each day in the week schedule.

4) **Optional:** Perform the following operations to edit the time durations.

- Move the cursor to the time duration and drag the time duration on the timeline bar to the desired position when the cursor turns to .
- Click the time duration and directly edit the start/end time in the appeared dialog.
- Move the cursor to the start or the end of time duration and drag to lengthen or shorten the time duration when the cursor turns to .

5) Click **Save**.

Related Operations

Copy to Whole Week Select one duration on the time bar, click **Copy to Whole Week** to copy all the duration settings on this time bar to other week days.

Delete Selected Select one duration on the time bar, click **Delete Selected** to delete this duration.

Clear Click **Clear** to clear all the duration settings in the week schedule.

4. To set the door status during the holiday, click the **Holiday** and perform the following operations.



- 1) Click **Remain Unlocked** or **Remain Locked**.
- 2) Click **Add**.
- 3) Enter the start date and end date.
- 4) Drag the cursor to draw the time duration, which means in that duration of time, the configured access group is activated.





Note

Up to 8 time durations can be set to one holiday period.

5) Perform the following operations to edit the time durations.

- Move the cursor to the time duration and drag the time duration on the timeline bar to the desired position when the cursor turns to .
- Click the time duration and directly edit the start/end time in the appeared dialog.
- Move the cursor to the start or the end of time duration and drag to lengthen or shorten the time duration when the cursor turns to .

6) **Optional:** Select the time duration(s) that need to be deleted, and then click  in the Operation column to delete the selected time duration(s).

7) **Optional:** Click  in the Operation column to clear all the time duration(s) in the time bar.

8) **Optional:** Click  in the Operation column to delete this added holiday period from the holiday list.

9) Click **Save**.

5. **Optional:** Click **Copy to** to copy the door status settings of this door to other door(s).

9.7.3 Configure Custom Wiegand Rule

Based on the knowledge of uploading rule for the third party Wiegand, you can set multiple customized Wiegand rules to communicate between the device and the third party card readers.

Before You Start

Wire the third party card readers to the device.

Steps

Note

- By default, the device disables the custom wiegand function. If the device enables the custom Wiegand function, all wiegand interfaces in the device will use the customized wiegand protocol.
 - Up to 5 custom Wiegands can be set.
 - For details about the custom Wiegand, see Custom Wiegand Rule Descriptions.
-

1. Click **Access Control** → **Advanced Function** → **Custom Wiegand** to enter the Custom Wiegand page.
 2. Select a custom Wiegand on the left.
 3. Create a Wiegand name.
-

Note

Up to 32 characters are allowed in the custom Wiegand name.

4. Click **Select Device** to select the access control device for setting the custom wiegand.
 5. Set the parity mode according to the property of the third party card reader.
-

Note

- Up to 80 bits are allowed in the total length.
 - The odd parity start bit, the odd parity length, the even parity start bit and the even parity length range from 1 to 80 bit.
 - The start bit of the card ID, the manufacturer code, the site code, and the OEM should range from 1 to 80 bit.
-
6. Set output transformation rule.
 - 1) Click **Set Rule** to open the Set Output Transformation Rules window.
 - 2) Select rules on the left list.

The selected rules will be added to the right list.
 - 3) **Optional**: Drag the rules to change the rule order.
 - 4) Click **OK**.
 - 5) In the Custom Wiegand tab, set the rule's start bit, length, and the decimal digit.
 7. Click **Save**.

9.7.4 Configure Card Reader Authentication Mode and Schedule

You can set the passing rules for the card reader of the access control device according to your actual needs.

Steps

1. Click **Access Control** → **Advanced Function** → **Authentication** to enter the authentication mode configuration page.
2. Select a card reader on the left to configure.
3. Set card reader authentication mode.
 - 1) Click **Configuration**.

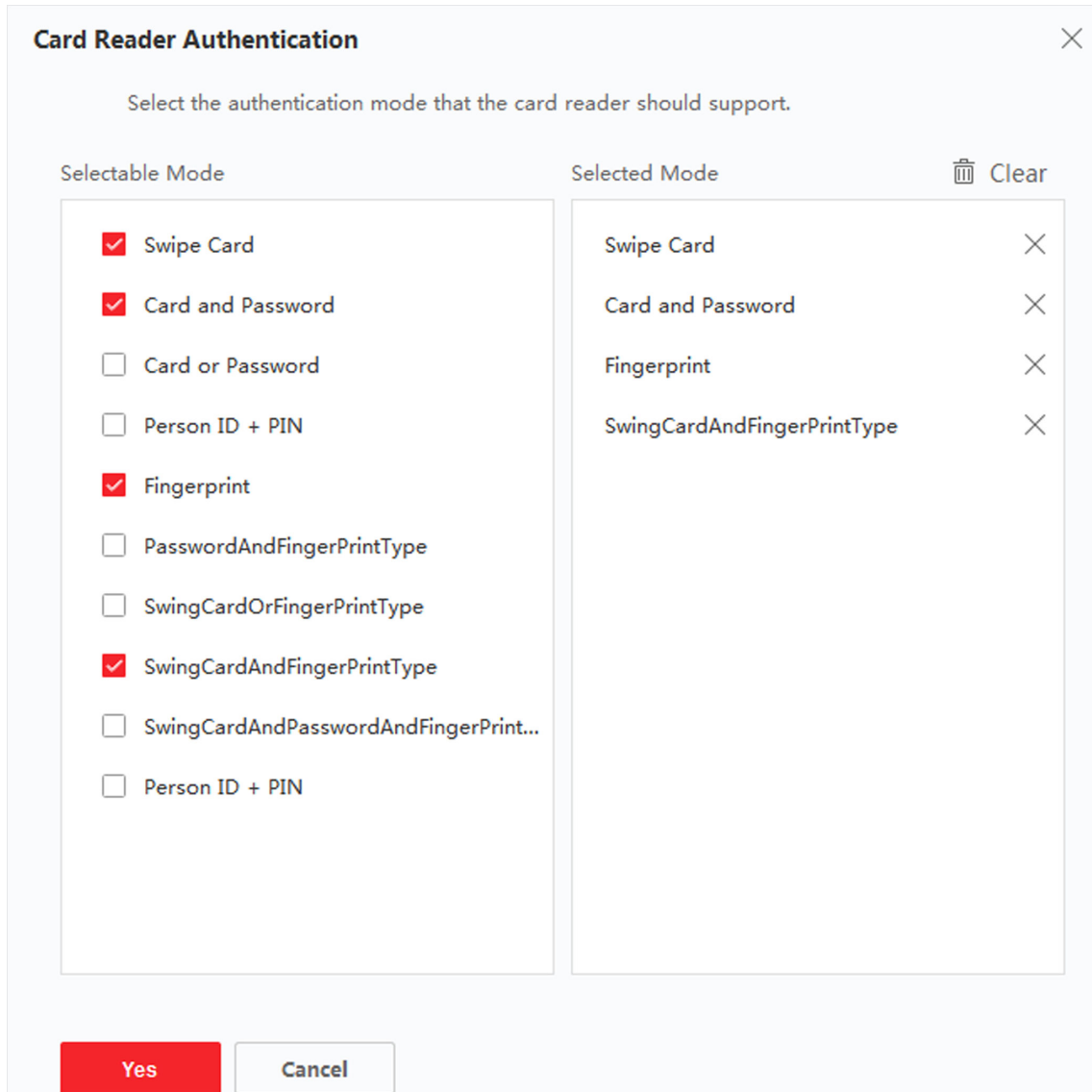

Figure 9-8 Select Card Reader Authentication Mode

 **Note**

PIN refers to the PIN code set to open the door. Refer to ***Configure Access Control Information*** .

- 2) Check the modes in the Available Mode list and they will be added to the selected modes list.

3) Click **OK**.

After selecting the modes, the selected modes will display as icons with different color.

4. Click the icon to select a card reader authentication mode, and drag the cursor to draw a color bar on the schedule, which means in that period of time, the card reader authentication is valid.
5. Repeat the above step to set other time periods.

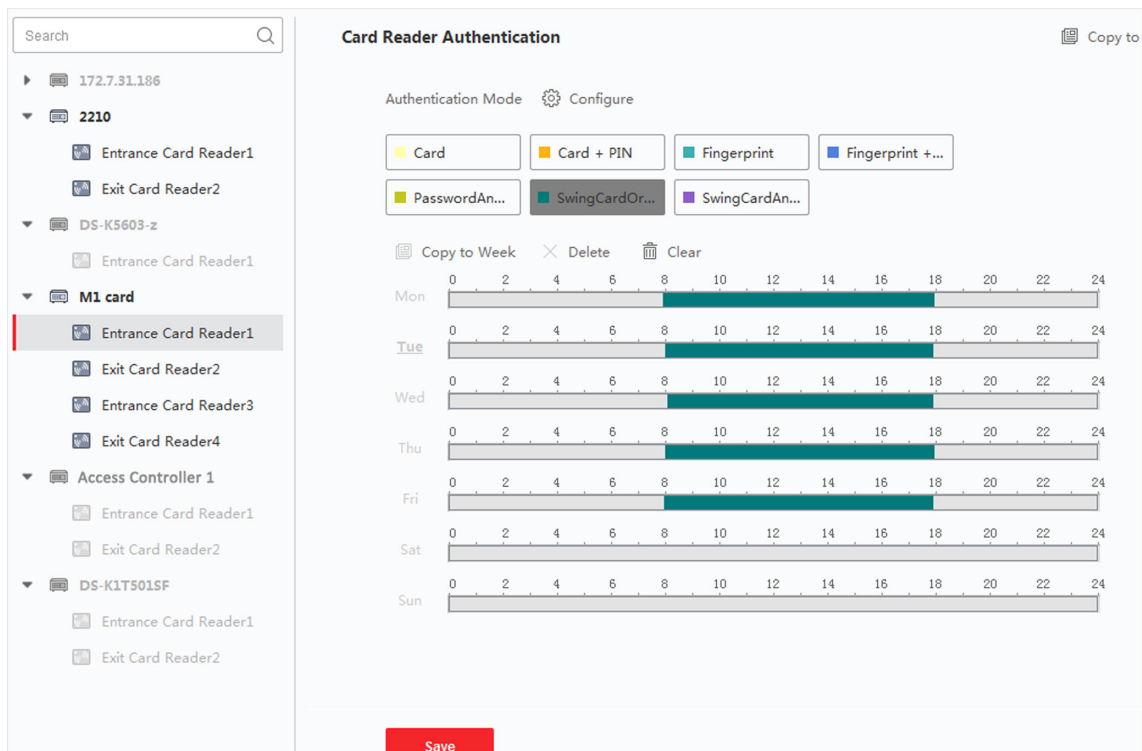

Figure 9-9 Set Authentication Modes for Card Readers

6. **Optional:** Select a configured day and click **Copy to Week** to copy the same settings to the whole week.
7. **Optional:** Click **Copy to** to copy the settings to other card readers.
8. Click **Save**.

9.7.5 Configure Device Parameters

After adding the access control device, you can set its parameters such as network parameters.

Set Network Parameters

After adding the access control device, you can set the device log uploading mode, and create EHome account via wired network.

Set Log Uploading Mode

You can set the mode for the device to upload logs via ISUP protocol.

Steps

Note

Make sure the device is not added by ISUP.

1. Enter the Access Control module.
 2. On the navigation bar on the left, enter **Advanced Function → More Parameters** .
 3. Select an access control device in the device list and enter **Network → Uploading Mode** .
 4. Select the center group from the drop-down list.
 5. Check **Enable** to enable to set the uploading mode.
 6. Select the uploading mode from the drop-down list.
 - Enable **N1** or **G1** for the main channel and the backup channel.
 - Select **Close** to disable the main channel or the backup channel
-

Note

- The main channel and the backup channel cannot enable N1 or G1 at the same time.
 - N1 refers to wired network.
-

7. Click **Save**.

Create EHome Account in Wired Communication Mode

You can set the account for EHome protocol in wired communication mode. Then you can add devices via EHome protocol.

Steps

Note

- This function should be supported by the device.
 - Make sure the device is not added by EHome.
-

1. Enter the Access Control module.
2. On the navigation bar on the left, enter **Advanced Function → More Parameters** .
3. Select an access control device in the device list and enter **Network → Network Center** .
4. Select the center group from the drop-down list.
5. Select the **Address Type** as **IP Address** or **Domain Name**.
6. Enter IP address or domain name according to the address type.
7. Enter the port number for the protocol.

Note

The port number of the wireless network and wired network should be consistent with the port number of EHome.

-
8. Select the **Protocol Type** as **EHome** and select EHome version.

Note

If set the EHome version as **5.0**, you should create an EHome key for the EHome account.

-
9. Set an account name for the network center.
 10. Click **Save**.

Enable M1 Card Encryption

M1 card encryption can improve the security level of authentication.

Steps

Note

The function should be supported by the access control device and the card reader.

-
1. Enter the Access Control module.
 2. On the navigation bar on the left, enter **Advanced Function** → **More Parameters** .
 3. Select an access control device in the device list and click **M1 Card Encryption Verification** to enter the M1 Card Encryption Verification page.
 4. Set the switch to on to enable the M1 card encryption function.
 5. Set the sector ID.

Note

- The sector ID ranges from 1 to 100.
- By default, Sector 13 is encrypted. It is recommended to encrypt sector 13.

-
6. Click **Save** to save the settings.

Set RS-485 Parameters

You can set the access control device's RS-485 parameters including the baud rate, data bit, the stop bit, parity type, flow control type, communication mode, work mode, and connection mode.

Before You Start

Add access control device to the client, and make sure the device supports RS-485 interface.

Steps

1. Enter the Access Control module.
2. On the navigation bar on the left, enter **Advanced Function** → **More Parameters** .

3. Select an access control device in the device list and click **RS-485** to enter the RS-485 Settings page.
4. Select the serial port number from the drop-down list to set the RS-485 parameters.
5. Set the baud rate, data bit, the stop bit, parity type, communication mode, working mode, and connection mode in the drop-down list.

Note

When the connection mode is **Connect Access Control Device**, you can select **Card No.** or **Person ID** as the output type.

-
6. Click **Save**.
 - The configured parameters will be applied to the device automatically.
 - When you change the working mode or connection mode, the device will reboot automatically.

Set Wiegand Parameters

You can set the access control device's Wiegand channel and the communication mode. After setting the Wiegand parameters, the device can connect to Wiegand card reader via Wiegand communication.

Steps

Note

This function should be supported by the device.

-
1. Enter the Access Control module.
 2. On the navigation bar on the left, enter **Advanced Function → More Parameters**.
 3. Select an access control device in the device list and click **Wiegand** to enter the Wiegand Settings page.
 4. Set the switch to on to enable the Wiegand function for the device.
 5. Select the Wiegand channel No. and the communication mode from the drop-down list.

Note

If you set **Communication Direction** as **Sending**, you are required to set the **Wiegand Mode** as **Wiegand 26**, **Wiegand 34**, **Wiegand 27**, or **Wiegand 35**.

-
6. Click **Save**.
 - The configured parameters will be applied to the device automatically.
 - After changing the communication direction, the device will reboot automatically.

9.8 Configure Linkage Actions for Access Control

You can configure different linkage actions for the event detected by the access control device. After that, linkage actions will be triggered once the event happens. This mechanism is used for notifying the security personnel the event, or triggering automatic access control in real time.

Two types of linkage actions are supported:

- **Client Actions:** When the event is detected, it will trigger the actions on the client, such as the client making an audible warning..
- **Device Actions:** When the event is detected, it will trigger the actions of a specific device, such as buzzing of a card reader and, opening/closing of a door, ..

9.8.1 Configure Client Actions for Access Event

Even if you are far away from an access point, you can still know what happens and how urgent the event is via the client by configuring client actions for the access event. Client actions here refer to the actions automatically executed by the client itself, such as making an audible warning and sending an email. Once an event is triggered, the client will notify the security personnel, so that he/she can handle the event in time.

Before You Start

Add access control device to the client.

Steps

1. Click *Event Configuration* → *Access Control Event* .

The added access control devices will display in the device list.

2. Select a resource (including device, alarm input, door, and card reader) from the device list.

The event types which the selected resource supports appear.

3. Select the event(s) and click *Edit Priority* to define the priority for the event(s), which can be used to filter events in the Event Center.

4. Set the linkage actions of the event.

- 1) Select the event(s) and click **Edit Linkage** to set the client actions when the event(s) are triggered.

Audible Warning

The client software gives an audible warning when the event is triggered. You can select alarm sound for the audible warning.



For details about setting the alarm sound, refer to *Set Alarm Sound* in the user manual of the client software.

Send Email

Send an email notification about the event to one or more receivers.

For details about setting email parameters, refer to *Set Email Parameters* in the user manual of the client software.

2) Click **OK**.

5. Enable the event so that when the event is detected, event will be sent to the client and the linkage actions will be triggered.
6. **Optional:** Click **Copy to** to copy the event settings to other access control device, alarm input, door, or card reader.

9.8.2 Configure Device Actions for Access Event

You can set the access control device's linkage actions for the access control device's triggered event. When the event is triggered, it can trigger the alarm output, host buzzer, and other actions on the same device.

Steps



It should be supported by the device.

1. Click **Access Control → Linkage Configuration** .
2. Select the access control device from the list on the left.
3. Click **Add** button to add a new linkage.
4. Select the event source as **Event Linkage**.
5. select the event type and detailed event to set the linkage.
6. In the Linkage Target area, set the property target to enable this action.

Buzzer on Controller

The audible warning of access control device will be triggered.

7. Click **Save**.
8. **Optional:** After adding the device linkage, you can do one or more of the following:

Edit Linkage Settings	Select the configured linkage settings in the device list and you can edit its event source parameters, including event source and linkage target.
Delete Linkage Settings	Select the configured linkage settings in the device list and click Delete to delete it.

9.8.3 Configure Device Actions for Card Swiping

You can set the access control device's linkage actions for the specified card swiping. When you swipe the specified card, it can trigger the alarm output, host buzzer, and other actions on the same device.

Steps

Note

It should be supported by the device.

1. Click **Access Control → Linkage Configuration** .
2. Select the access control device from the list on the left.
3. Click **Add** button to add a new linkage.
4. Select the event source as **Card Linkage**.
5. Enter the card number or select the card from the dropdown list.
6. Select the card reader where the card swipes to trigger the linked actions.
7. In the Linkage Target area, set the property target to enable this action.

Buzzer on Controller

The audible warning of access control device will be triggered.

Buzzer on Reader

The audible warning of card reader will be triggered.

8. Click **Save**.

When the card (configured in Step 5) swipes on the card reader (configured in Step 6), it can trigger the linked actions (configured in step 7).

9. **Optional:** After adding the device linkage, you can do one or more of the following:

- | | |
|--------------------------------|--|
| Delete Linkage Settings | Select the configured linkage settings in the device list and click Delete to delete it. |
| Edit Linkage Settings | Select the configured linkage settings in the device list and you can edit its event source parameters, including event source and linkage target. |

9.8.4 Configure Device Actions for Person ID

You can set the access control device's linkage actions for the specified person ID. When access control device detects the specified person ID, it can trigger the alarm output, host buzzer, and other actions on the same device.

Steps

Note

It should be supported by the device.

1. Click **Access Control → Linkage Configuration** .
 2. Select the access control device from the list on the left.
 3. Click **Add** button to add a new linkage.
 4. Select the event source as **Person Linkage**.
 5. Enter the employee number or select the person from the dropdown list.
-

6. Select the card reader where the card swipes to trigger the linked actions.
7. In the Linkage Target area, set the property target to enable this action.

Buzzer on Controller

The audible warning of access control device will be triggered.

Buzzer on Reader

The audible warning of card reader will be triggered.

8. Click **Save**.
9. **Optional:** After adding the device linkage, you can do one or more of the following:

Delete Linkage Settings	Select the configured linkage settings in the device list and click Delete to delete it.
Edit Linkage Settings	Select the configured linkage settings in the device list and you can edit its event source parameters, including event source and linkage target.

9.9 Door Control

In Monitoring module, you can view the real-time status of the doors managed by the added access control device. You can also control the doors such as open/close the door, or remain the door open/closed via the client remotely. The real-time access event are displayed in this module. You can view the access details and person details.

Note

For the user with door control permission, the user can enter the Monitoring module and control the door. Or the icons used for control will not show. For setting the user permission, refer to ***Person Management***.

9.9.1 Control Door Status

You can control the status for a single door, including opening door, closing door, remaining the door open, and remaining the door closed.

Steps

1. Click **Monitoring** to enter the status monitoring page.
2. Select an access point group on the upper-right corner.

Note

For managing the access point group, refer to *Group Management* in the user manual of the client software.

The doors in the selected access control group will display.

3. Click a door icon to select a door, or press **Ctrl** and select multiple doors.
4. Click the following buttons to control the door.

Open Door

When the door is locked, unlock it and it will be open for once. After the open duration, the door will be closed and locked again automatically.

Close Door

When the door is unlocked, lock it and it will be closed. The person who has the access authorization can access the door with credentials.

Remain Open

The door will be unlocked (no matter closed or open). All the persons can access the door with no credentials required.

Remain Closed

The door will be closed and locked. No person can access the door even if he/she has the authorized credentials, except the super users.

Capture

Capture a picture manually.



Note

The **Capture** button is available when the device supports capture function. The picture is saved in the PC running the client. For setting the saving path, refer to *Set File Saving Path* in the user manual of the client software.

Result

The icon of the doors will change in real-time according to the operation if the operation is succeeded.

9.9.2 Check Real-Time Access Records

The access records will display in real time, including card swiping records, fingerprint comparison records, etc. You can view the person information and view the picture captured during access.

Steps

1. Click **Monitoring** and select a group from the drop-down list on the upper-right corner.
The access records triggered at the doors in the selected group will display in real time. You can view the details of the records, including card No., person name, organization, event time, etc.
2. **Optional:** Check the event type and event status so that these events will show in the list if the events are detected. The events of unchecked type or status will not be displayed in the list.
3. **Optional:** Check **Show Latest Event** and the latest access record will be selected and displayed at the top of the record list.
4. **Optional:** Click the event to view the accessed person details, including person pictures (captured picture and profile), person No., person name, organization, phone, contact address, etc.

 **Note**

You can double click the captured picture to enlarge it to view the details.

-
- 5. Optional:** Right click on the column name of the access event table to show or hide the column according to actual needs.

Appendix A. Tips for Scanning Fingerprint

Recommended Finger

Forefinger, middle finger or the third finger.

Correct Scanning

The figure displayed below is the correct way to scan your finger:

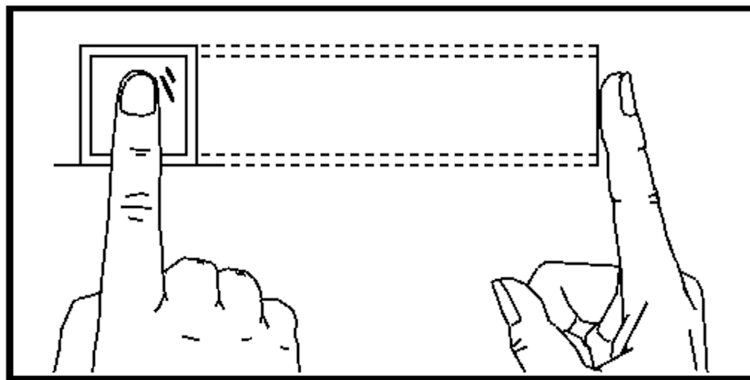

You should press your finger on the scanner horizontally. The center of your scanned finger should align with the scanner center.

Incorrect Scanning

The figures of scanning fingerprint displayed below are incorrect:

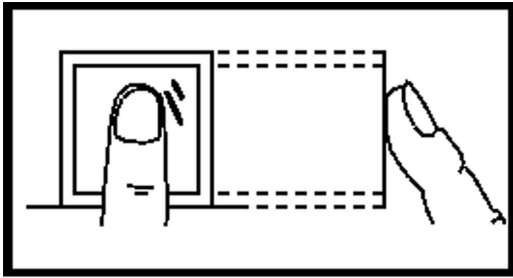

Vertical

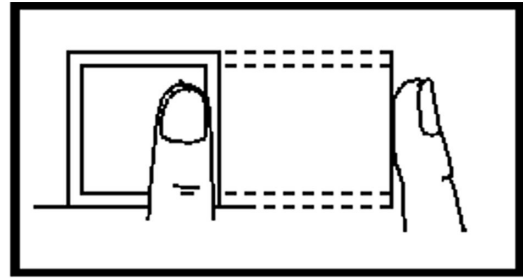

Edge I

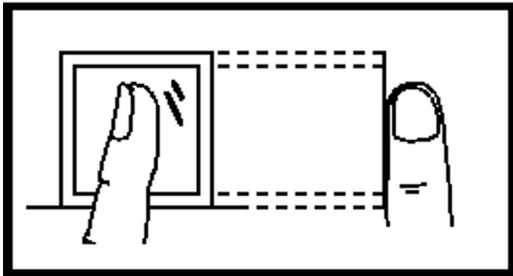

Side

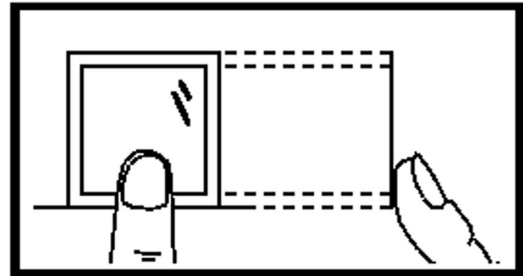

Edge II

Environment

The scanner should avoid direct sun light, high temperature, humid conditions and rain. When it is dry, the scanner may not recognize your fingerprint successfully. You can blow your finger and scan again.

Others

If your fingerprint is shallow, or it is hard to scan your fingerprint, we recommend you to use other authentication methods.

If you have injuries on the scanned finger, the scanner may not recognize. You can change another finger and try again.

Appendix B. Dimension

Dimension of Device

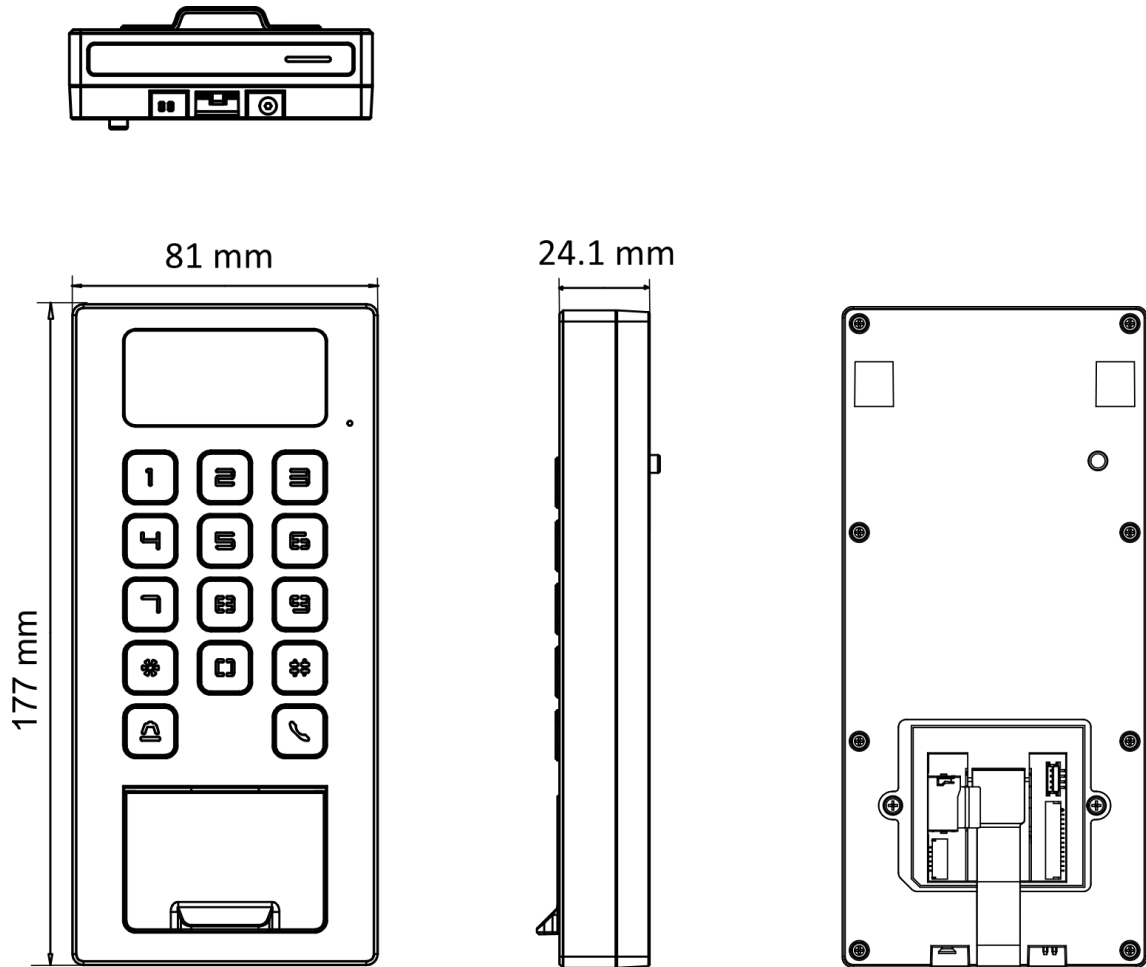



See Far, Go Further